



Claus y Bath, S.L., empresa creada en Valencia en 2011 presenta su nuevo catálogo.

Lanzamos al mercado nuevas griferías de cocina y baño, complementos y accesorios, así como una completísima gama de conjuntos para la ducha.

Todos nuestros productos son fabricados en latón y acero SS304, y las monturas y cartuchos que utilizamos cuentan con las correspondientes certificaciones.

Tenemos diseño, variedad de acabados, calidad y un magnífico precio. Todo unido a un excelente servicio hacen de nuestro catálogo una de las mejores opciones del mercado.

Esperamos sea de su agrado.



# INDICE

■ Grifería de <b>BAÑO</b> _____	05
■ Conjuntos de <b>DUCHA</b> _____	157
■ Conjuntos <b>EMPOTRADOS</b> _____	197
■ Grifería de <b>COCINA</b> _____	227
■ Grifería <b>ESPECIAL</b> _____	281
■ <b>COMPLEMENTOS</b> _____	301
■ <b>REPUESTOS</b> _____	346

# Grifería de **BAÑO**

■ Serie BARI	06 / 13
■ Serie BARI GRIS METAL	14 / 21
■ Serie TURIN	22 / 31
■ Serie TURIN NEGRO	32 / 41
■ Serie TURIN ORO	42 / 51
■ Serie TURIN ROSA	52 / 61
■ Serie TURIN GRIS METAL	62 / 71
■ Serie KU	72 / 81
■ Serie KU NEGRO	82 / 89
■ Serie CIES	90 / 93
■ Serie VARTA	94 / 97
■ Serie YDRA	98 / 101
■ Serie BONN	102 / 111
■ Serie KOBÁ	112 / 117
■ Serie KOBÁ NEGRO	118 / 123
■ Serie KOBÁ ORO	124 / 127
■ Serie JADE	128 / 135
■ Serie JADE NEGRO	136 / 143
■ Serie ZURICH	144 / 147
■ Serie ALFA	148 / 149
■ Serie CLASSIC	150 / 153
■ Serie CLASSIC BRONCE	154 / 155

# Serie BARI



**121641**

**Monomando lavabo / Basin mixer**

Acabado cromo  
Cartucho 26 mm

PVP: 76,00 €

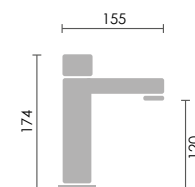

**121646**

**Monomando lavabo alto / Basin mixer**

Acabado cromo  
Cartucho 26 mm

PVP: 120,00 €

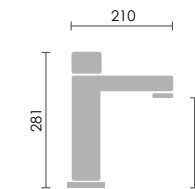

**121642**

**Monomando bidé / Bidet mixer**

Acabado cromo  
Cartucho 26 mm

PVP: 76,00 €

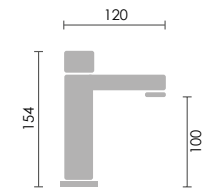

**121643**

**Monomando baño ducha / Bathtub mixer**

Acabado cromo  
Cartucho 35 mm

PVP: 135,00 €

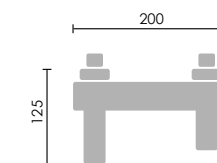

**121644**

**Monomando ducha / Shower mixer**

Acabado cromo  
Cartucho 35 mm

PVP: 95,00 €

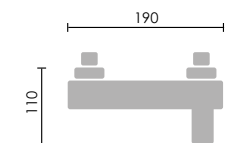

Incluido el kit de ducha. Flexo, mango de ducha y soporte.



# Serie **BARI**

**121647**

**Monomando lavabo empotrado / In wall basin mixer**

Caja registrable  
Acabado cromo  
Cartucho 35 mm.

**PVP: 105,00 €**

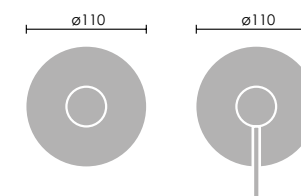

# Serie **BARI**

## 121650

### Conjunto Monomando

Rociador antical acero SS304 de 250 mm  
 Monomando empotrado de 2 vías  
 Caja registrable  
 Brazo de ducha de 1/2x37 cm  
 Codo de ducha c/ soporte integrado  
 Flexo reforzado cromado 1,50-2,0 m.  
 Ducha de 3 posiciones  
 Acabado: Cromo

PVP: 210,00 €

## 121648

### Grifo monomando empotrado

Acabado cromo  
 Incluye caja registrable  
 No incluye flexo ni mango de ducha

PVP: 115,00 €



No incluye flexo ni mango de ducha





# Serie **BARI**

**122018**

**Conjunto Monomando cartucho 35 mm**

Barra extensible ( De 870 a 1350 mm )  
Rociador antical acero 250 mm  
Flexo cónico reforzado de 1,5-2,0 m  
Ducha modelo 300 - 3 posiciones  
Acabado cromo

**PVP: 195,00 €**

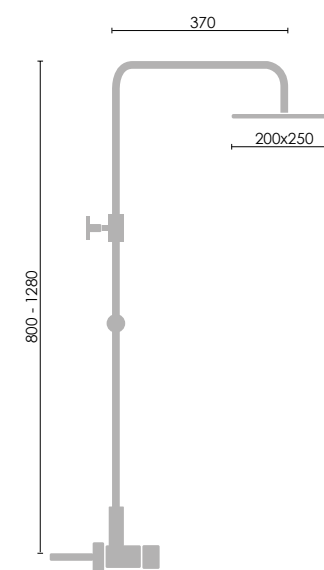

# Serie **BARI** Gris metal PVD



## 121641GM

**Monomando lavabo / Basin mixer**

Acabado gris metal  
Cartucho 26 mm

PVP: 88,00 €

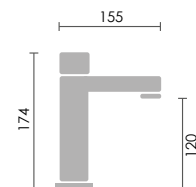

## 121646GM

**Monomando lavabo alto / Basin mixer**

Acabado gris metal  
Cartucho 26 mm.

PVP: 140,00 €

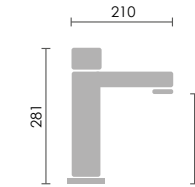

## 121642GM

**Monomando bidé / Bidet mixer**

Acabado gris metal  
Cartucho 26 mm.

PVP: 88,00 €

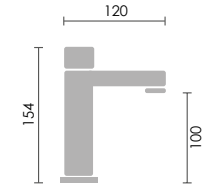

## 121643GM

**Monomando baño ducha / Bathtub mixer**

Acabado gris metal  
Cartucho 35 mm.

PVP: 156,00 €

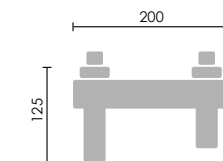

## 121644GM

**Monomando ducha / Shower mixer**

Acabado gris metal  
Cartucho 35 mm.

PVP: 112,00 €

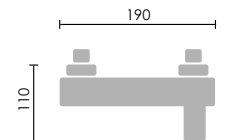

Incluido el kit de ducha. Flexo, mango de ducha y soporte.



# Serie **BARI** Gris metal

**121647GM**

**Monomando lavabo empotrado / In wall basin mixer**

Acabado gris metal  
Cartucho 35 mm.

PVP: 130,00 €

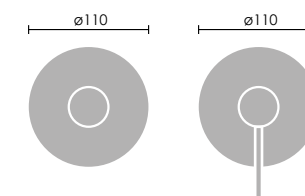

# Serie **BARI** Gris metal

## 121650GM

### Conjunto Monomando

Rociador antical acero SS304 de 250 mm  
 Monomando empotrado de 2 vías  
 Caja registrable  
 Brazo de ducha de 1/2x37 cm  
 Codo de ducha c/ soporte integrado  
 Flexo reforzado PVC gris de 1,70 m.  
 Ducha de 3 posiciones  
 Acabado: Gris metal

PVP: 255,00 €

## 121648GM

### Grifo monomando empotrado

Acabado gris metal  
 Incluye caja registrable  
 No incluye flexo ni mango de ducha

PVP: 135,00 €



No incluye flexo ni mango de ducha





# Serie **BARI** Gris metal

## 122018GM

### Conjunto Monomando cartucho 35 mm

Barra extensible ( De 870 a 1350 mm )  
Rociador antical acero 250 mm  
Flexo cónico de PVC 1,70 gris metal.  
Ducha modelo 350 - 3 posiciones  
Acabado gris metal

PVP: 265,00 €

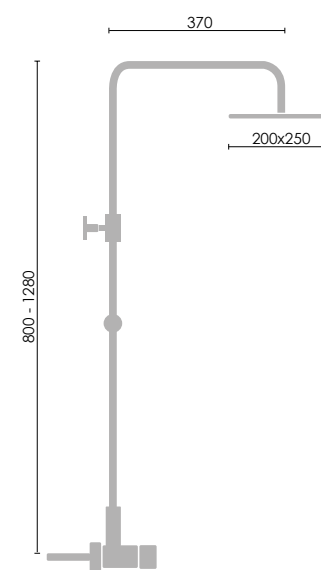

# Serie TURÍN



**121141**

**Monomando lavabo / Basin mixer**

Acabado cromo  
Cartucho 25 mm.

PVP: 62,00 €

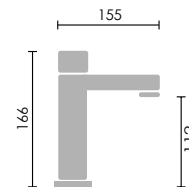

**121146**

**Monomando lavabo alto / Basin mixer**

Acabado cromo  
Cartucho 25 mm.

PVP: 83,00 €

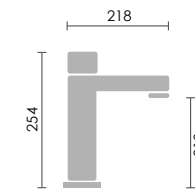

**121142**

**Monomando bidé / Bidet mixer**

Acabado cromo  
Cartucho 25 mm.

PVP: 62,00 €

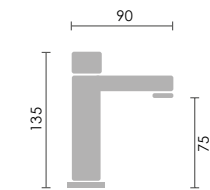

**121143**

**Monomando baño ducha / Bathtub mixer**

Acabado cromo  
Cartucho 35 mm.

PVP: 123,00 €

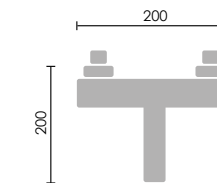

**121144**

**Monomando ducha / Shower mixer**

Acabado cromo  
Cartucho 35 mm.

PVP: 95,00 €

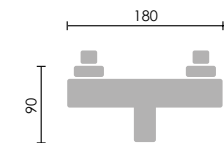

Incluido el kit de ducha. Flexo, mango de ducha y soporte.

# Serie **TURÍN**



**121145**

**Monomando lavabo empotrado / In wall basin mixer**

Acabado cromo  
Cartucho 35 mm.

PVP: 87,00 €



**121108**

**Conjunto sustitución bidé 2 aguas /  
Supply bidet**

Flexo cromado 1,20 antitorsión  
Acabado cromo  
Cartucho 35 mm.

PVP: 95,00 €



# Serie **TURÍN**

## 121045

### Conjunto monomando empotrado

Rociador antical acero SS304 de 250 mm  
 Monomando empotrado de 2 vías  
 Caja registrable  
 Brazo de ducha de 1/2x37 cm  
 Salida para flexo c/ soporte integrado  
 Flexo reforzado cromado 1,50-2,0 m.  
 Ducha de 3 posiciones  
 Acabado: Cromo

PVP: 225,00 €

## 121148

### Grifo monomando empotrado

Incluye caja registrable  
 No incluye flexo ni mango de ducha

PVP: 155,00 €

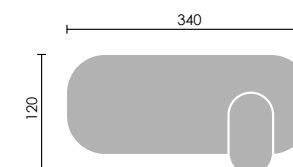

# Serie **TURÍN**

## 121650

### Conjunto monomando empotrado

Rociador antical acero SS304 de 250 mm  
 Monomando empotrado de 2 vías  
 Caja registrable  
 Brazo de ducha de 1/2x37 cm  
 Codo de ducha c/ soporte integrado  
 Flexo reforzado PVC gris de 1,70 m.  
 Ducha de 3 posiciones  
 Acabado: Cromo

PVP: 195,00 €

## 121649

### Grifo monomando empotrado

Incluye caja registrable  
 No incluye flexo ni mango de ducha

PVP: 105,00 €



No incluye flexo ni mango de ducha



# Serie TURÍN

**122012**

**Conjunto monomando**

Cartucho 35 mm  
 Barra extensible (de 870 a 1350 mm)  
 Rociador antical acero 250 mm  
 Flexo reforzado 1,5-2,0 m  
 Ducha de 3 posiciones modelo 300  
 Acabado cromo

**PVP: 192,00 €**

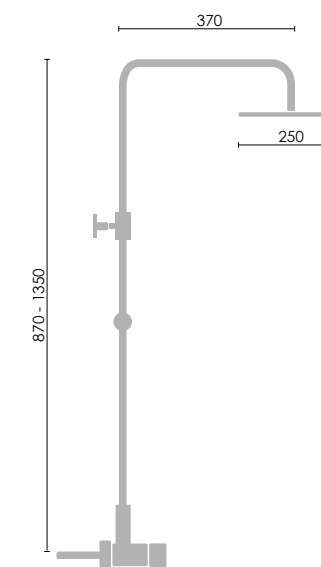

# Serie **TURÍN** Negro

PVD



## 121141NG

**Monomando lavabo / Basin mixer**

Acabado negro mate

Cartucho 25 mm.

PVP: 74,00 €

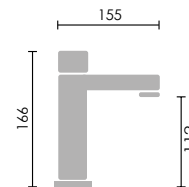

## 121146NG

**Monomando lavabo alto / Basin mixer**

Acabado negro mate

Cartucho 25 mm.

PVP: 95,00 €

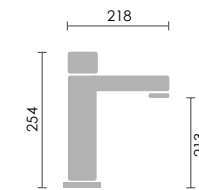

## 121142NG

**Monomando bidé / Bidet mixer**

Acabado negro mate

Cartucho 25 mm.

PVP: 74,00 €

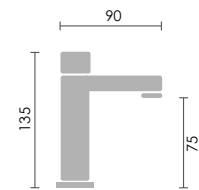

## 121143NG

**Monomando baño ducha / Bathtub mixer**

Acabado negro mate

Cartucho 35 mm.

PVP: 144,00 €

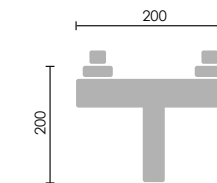

**121144NG Monomando ducha / Shower mixer**

Acabado negro mate

Cartucho 35 mm.

PVP: 115,00 €

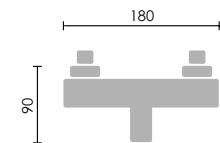

Incluido el kit de ducha. Flexo, mango de ducha y soporte.

# Serie **TURÍN** Negro



## **121145NG**

**Monomando lavabo empotrado / In wall basin mixer**

Acabado negro  
Cartucho 35 mm.

PVP: 98,00 €



## **121108 NG**

**Conjunto sustitución bidé 2 aguas /  
Supply bidet**

Flexo 1,20 PVC negro  
Acabado negro mate  
Cartucho 35 mm.

PVP: 118,00 €

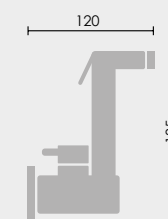

# Serie **TURÍN** Negro

## 121045NG

### Conjunto monomando empotrado

Rociador antical acero SS304 de 250 mm  
 Monomando empotrado de 2 vías  
 Caja registrable  
 Brazo de ducha de 1/2x37 cm  
 Salida para flexo c/ soporte integrado  
 Flexo 1,7 PVC NEGRO  
 Ducha de 3 posiciones  
 Acabado: Negro mate

PVP: 330,00 €

## 121148NG

### Grifo monomando empotrado

Incluye caja registrable  
 No incluye flexo ni mango de ducha

PVP: 186,00 €

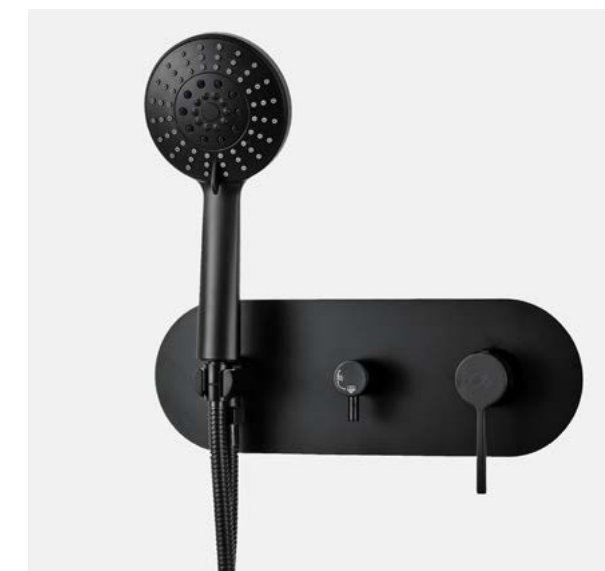
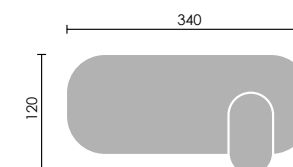

# Serie **TURÍN** Negro

## 121650NG

### Conjunto monomando empotrado

Rociador antical acero SS304 de 250 mm  
 Monomando empotrado de 2 vías  
 Caja registrable  
 Brazo de ducha de 1/2x37 cm  
 Codo de ducha c/ soporte integrado  
 Flexo 1,7 PVC NEGRO  
 Ducha de 3 posiciones  
 Acabado: Negro

PVP: 245,00 €

## 121649NG

### Grifo monomando empotrado

Incluye caja registrable  
 No incluye flexo ni mango de ducha

PVP: 125,00 €

No incluye flexo ni mango de ducha



# Serie **TURÍN** Negro

## 122012NG

### Conjunto monomando

Cartucho 35 mm  
 Barra extensible (de 870 a 1350 mm)  
 Rociador antical acero 250 mm  
 Flexo de PVC 1,50 negro mate  
 Ducha modelo 320 - 5 posiciones  
 Acabado negro mate

PVP: 265,00 €

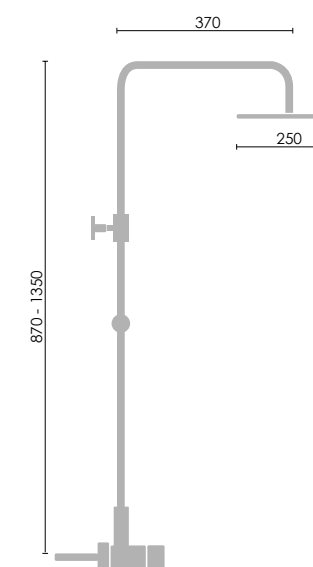

# Serie **TURÍN** Oro

PVD



**121146OR**

**Monomando lavabo alto / Basin mixer**

Acabado oro cepillado  
Cartucho 35 mm.

PVP: 95,00 €

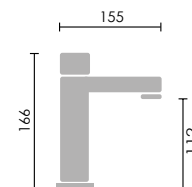

**121141OR**

**Monomando lavabo / Basin mixer**

Acabado oro cepillado  
Cartucho 25 mm.

PVP: 74,00 €

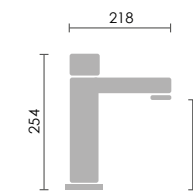

**121142OR**

**Monomando bidé / Bidet mixer**

Acabado oro cepillado  
Cartucho 25 mm.

PVP: 74,00 €

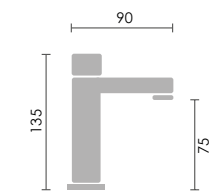

**121143OR**

**Monomando baño ducha / Bathtub mixer**

Acabado oro cepillado  
Cartucho 35 mm.

PVP: 144,00 €

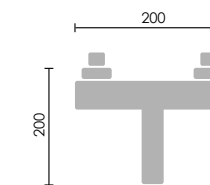

**121144OR**

**Monomando ducha / Shower mixer**

Acabado oro cepillado  
Cartucho 35 mm.

PVP: 115,00 €

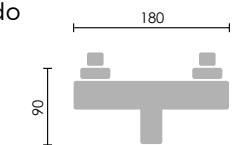

Incluido el kit de ducha. Flexo, mango de ducha y soporte.

# Serie **TURÍN** Oro



**121145OR**

**Monomando lavabo empotrado / In wall basin mixer**

Acabado oro cepillado  
Cartucho 35 mm.

PVP: 98,00 €

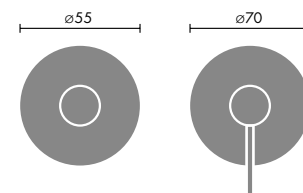

**121108OR**

**Conjunto sustitución bidé 2 aguas /  
Supply bidet**

Flexo PVC 1,20 oro cepillado  
Acabado oro cepillado  
Cartucho 35 mm.

PVP: 135,00 €

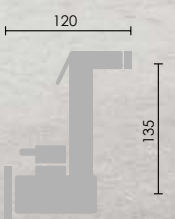

# Serie **TURÍN** Oro

## 121045OR

### Conjunto monomando empotrado

Rociador antical acero SS304 de 250 mm  
 Monomando empotrado de 2 vías  
 Caja registrable  
 Brazo de ducha de 1/2x37 cm  
 Salida para flexo c/ soporte integrado  
 Flexo de PVC 1,50 m.  
 Ducha de 3 posiciones  
 Acabado: Oro cepillado

PVP: 330,00 €

## 121148OR

### Grifo monomando empotrado

Incluye caja registrable  
 No incluye flexo ni mango de ducha

PVP: 186,00 €

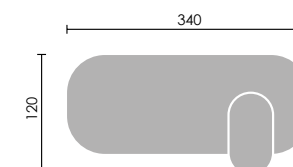

# Serie **TURÍN** Oro

## **121650OR**

### **Conjunto Monomando**

Rociador antical acero SS304 de 250 mm  
 Monomando empotrado de 2 vías  
 Caja registrable  
 Brazo de ducha de 1/2x37 cm  
 Codo de ducha c/ soporte integrado  
 Flexo PVC Oro de 1,70 m.  
 Ducha de 3 posiciones  
 Acabado: Oro Cepillado

**PVP: 245,00 €**

## **121649OR**

### **Grifo monomando empotrado**

Incluye caja registrable  
 No incluye flexo ni mango de ducha

**PVP: 125,00 €**



No incluye flexo ni mango de ducha



# Serie **TURÍN** Oro

## 122012OR

### Monomando cartucho 35 mm

Barra extensible (de 870 a 1350 mm)  
Rociador antical acero 250 mm  
Flexo de PVC 1,50 oro cepillado  
Ducha modelo 330 - 5 posiciones  
Acabado oro cepillado

PVP: 265,00 €

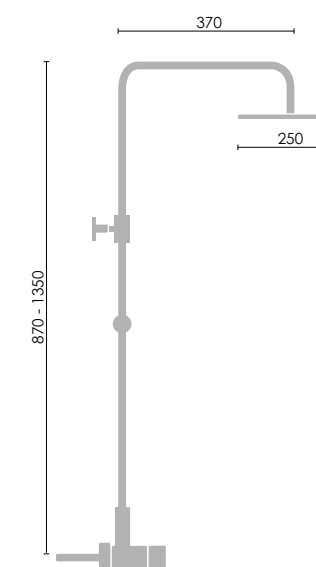

# Serie **TURÍN** Rosa

PVD

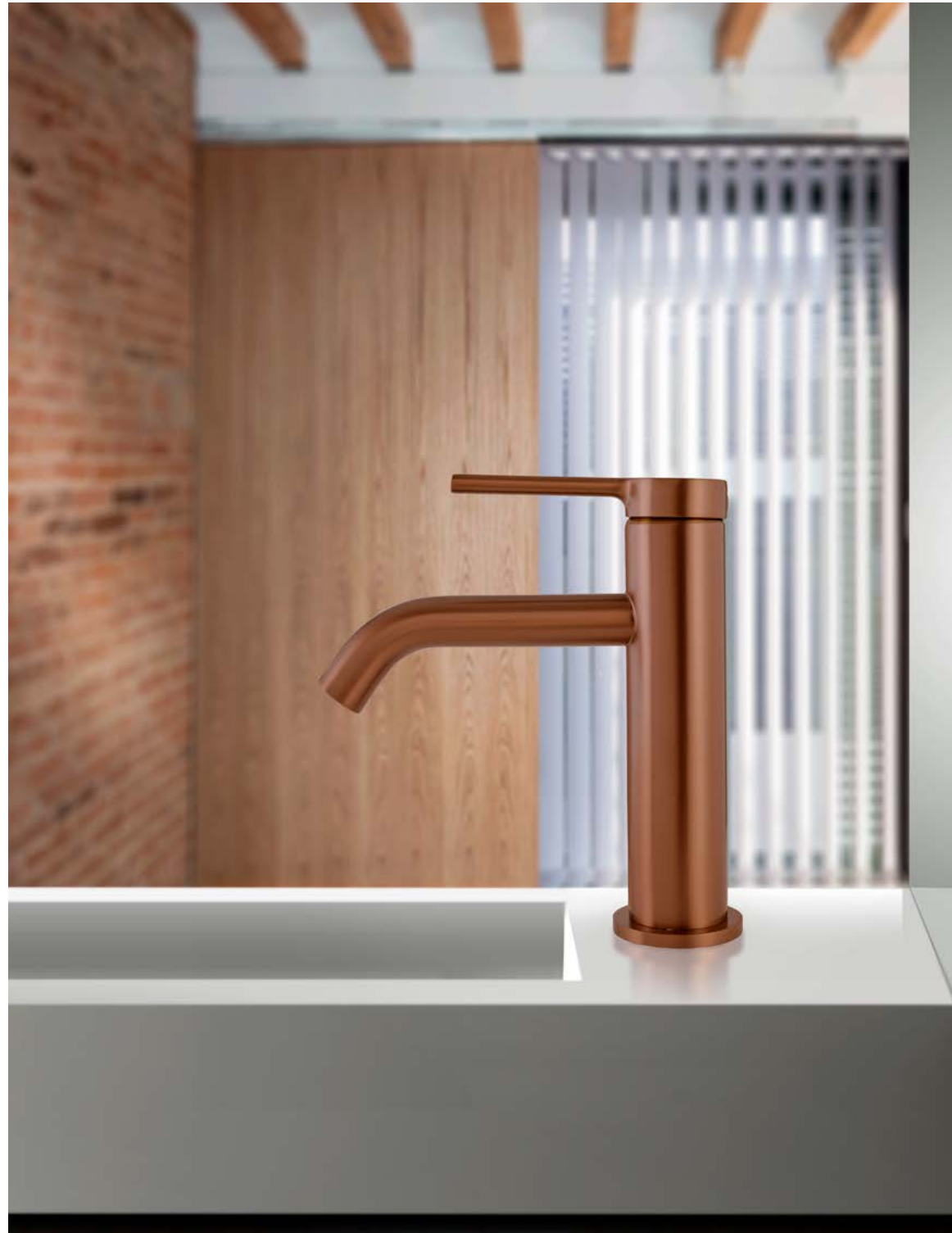

**121141RC**

**Monomando lavabo / Basin mixer**

Acabado rosa cepillado  
Cartucho 25 mm.

**PVP: 74,00 €**

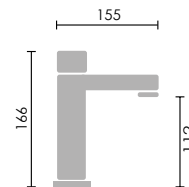

**121146RC**

**Monomando lavabo alto / Basin mixer**

Acabado rosa cepillado  
Cartucho 25 mm.

**PVP: 95,00 €**

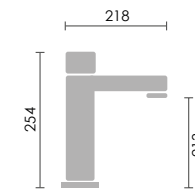

**121142RC**

**Monomando bidé / Bidet mixer**

Acabado rosa cepillado  
Cartucho 25 mm.

**PVP: 74,00 €**

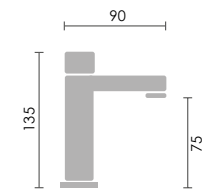

**121143RC**

**Monomando baño ducha / Bathtub mixer**

Acabado rosa cepillado  
Cartucho 35 mm.

**PVP: 144,00 €**

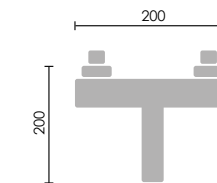

**121144RC**

**Monomando ducha / Shower mixer**

Acabado rosa cepillado  
Cartucho 35 mm.

**PVP: 115,00 €**

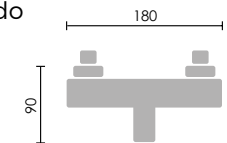

Incluido el kit de ducha. Flexo, mango de ducha y soporte.

# Serie **TURÍN** Rosa



**121145RC**

**Monomando lavabo empotrado / In wall basin mixer**

Acabado rosa cepillado  
Caja registrable  
Cartucho 35 mm.

PVP: 98,00 €

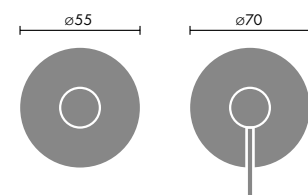

**121108RC**

**Conjunto sustitución bidé 2 aguas /  
Supply bidet**

Flexo 1,20 PVC ROSA  
Acabado Rosa  
Cartucho 35 mm.

PVP: 135,00 €

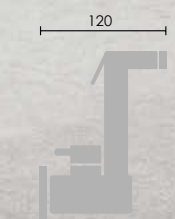

# Serie **TURÍN** Rosa

## 121045RC

### Conjunto Monomando

Rociador antical acero SS304 de 250 mm  
 Monomando empotrado de 2 vías  
 Caja registrable  
 Brazo de ducha de 1/2x37 cm  
 Salida para flexo c/ soporte integrado  
 Flexo 1.7 PVC ROSA  
 Ducha de 3 posiciones  
 Acabado: Rosa cepillado

PVP: 330,00 €

## 121148RC

### Grifo monomando empotrado

Incluye caja registrable  
 No incluye flexo ni mango de ducha

PVP: 186,00 €

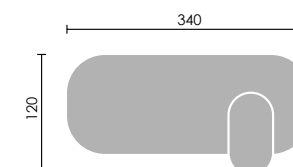

# Serie **TURÍN** Rosa

## 121650RC

### Conjunto monomando empotrado

Rociador antical acero SS304 de 250 mm  
 Monomando empotrado de 2 vías  
 Caja registrable  
 Brazo de ducha de 1/2x37 cm  
 Codo de ducha c/ soporte integrado  
 Flexo 1,7 PVC ROSA  
 Ducha de 3 posiciones  
 Acabado: Rosa Cepillado

PVP: 245,00 €

## 121649RC

### Grifo monomando empotrado

Incluye caja registrable  
 No incluye flexo ni mango de ducha

PVP: 125,00 €



No incluye flexo ni mango de ducha



# Serie **TURÍN** Rosa

## 122012RC

### Conjunto Monomando cartucho 35 mm

Barra extensible (de 870 a 1350 mm)  
 Rociador antical acero 250 mm  
 Flexo 1,7 PVC ROSA  
 Ducha modelo 360 - 3 posición  
 Acabado rosa cepillado

PVP: 265,00 €

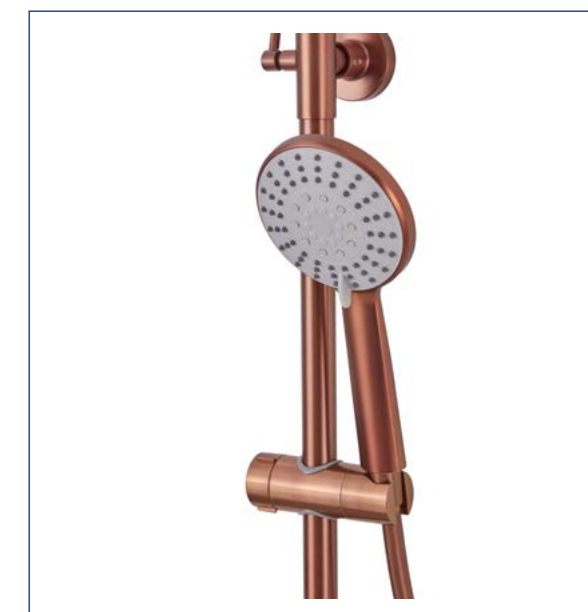
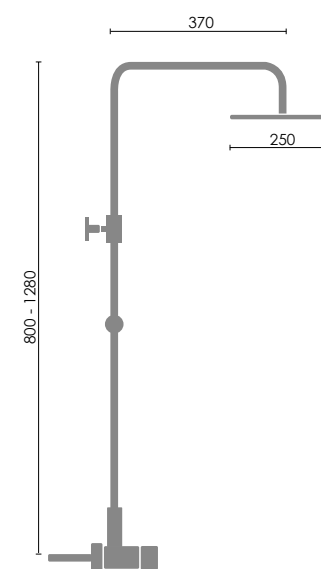

# Serie **TURÍN** Gris metal PVD



**121146GM**

**Monomando lavabo alto / Basin mixer**

Acabado gris metal  
Cartucho 25 mm

PVP: 95,00 €

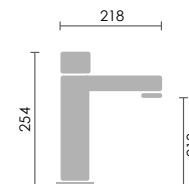

**121141GM**

**Monomando lavabo / Basin mixer**

Acabado gris metal  
Cartucho 25 mm

PVP: 74,00 €

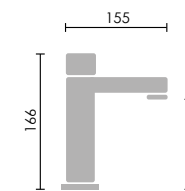

**121142GM**

**Monomando bidé / Bidet mixer**

Acabado gris metal  
Cartucho 25 mm

PVP: 74,00 €

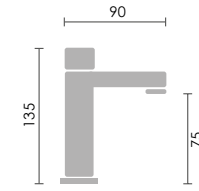

**121143GM**

**Monomando baño ducha / Bathtub mixer**

Acabado gris metal  
Cartucho 35 mm

PVP: 144,00€

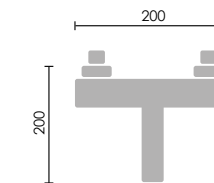

**121144GM**

**Monomando ducha / Shower mixer**

Acabado gris metal  
Cartucho 35 mm

PVP: 115,00€

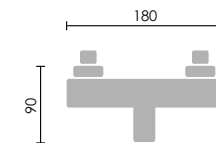

Incluido el kit de ducha. Flexo, mango de ducha y soporte.

# Serie **TURÍN** Gris metal



## 121145GM

**Monomando lavabo empotrado / In wall basin mixer**

Acabado gris metal  
Cartucho 35 mm.

PVP: 98,00 €

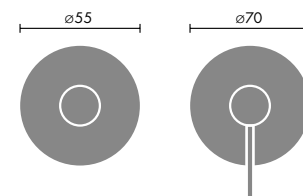

## 121108GM

**Conjunto sustitución bidé 2 aguas / Supply bidet**

Flexo 1,7 PVC GRIS  
Acabado gris metal  
Cartucho 35 mm.

PVP: 135,00 €

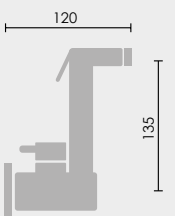

# Serie **TURÍN** Gris metal



## **121045GM**

### **Conjunto Monomando**

Rociador antical acero SS304 de 250 mm  
 Monomando empotrado de 2 vías  
 Caja registrable  
 Brazo de ducha de 1/2x37 cm  
 Codo de ducha c/ soporte integrado  
 Flexo reforzado PVC gris de 1,70 m.  
 Ducha de 3 posiciones  
 Acabado: Gris metal

**PVP: 330,00 €**

## **121148GM**

### **Grifo monomando empotrado**

Incluye caja registrable  
 No incluye flexo ni mango de ducha

**PVP: 186,00 €**

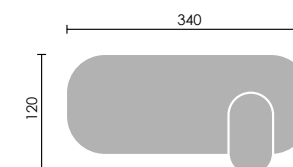

# Serie **TURÍN** Gris metal

## **121650GM**

### **Conjunto monomando empotrado**

Rociador antical acero SS304 de 250 mm  
 Monomando empotrado de 2 vías  
 Caja registrable  
 Brazo de ducha de 1/2x37 cm  
 Codo de ducha c/ soporte integrado  
 Flexo PVC Gris de 1,70 m.  
 Ducha de 3 posiciones  
 Acabado: Gris Metal

**PVP: 245,00 €**

## **121649GM**

### **Grifo monomando empotrado**

Incluye caja registrable  
 No incluye flexo ni mango de ducha

**PVP: 125,00 €**



No incluye flexo ni mango de ducha



# Serie **TURÍN** Gris metal



**122012GM**

**Conjunto Monomando cartucho 35 mm**

Barra extensible ( De 870 a 1350 mm )  
 Rociador antical acero 250 mm  
 Flexo cónico de PVC 1,70 gris metal.  
 Ducha modelo 350 - 3 posiciones  
 Acabado gris metal

**PVP: 265,00 €**

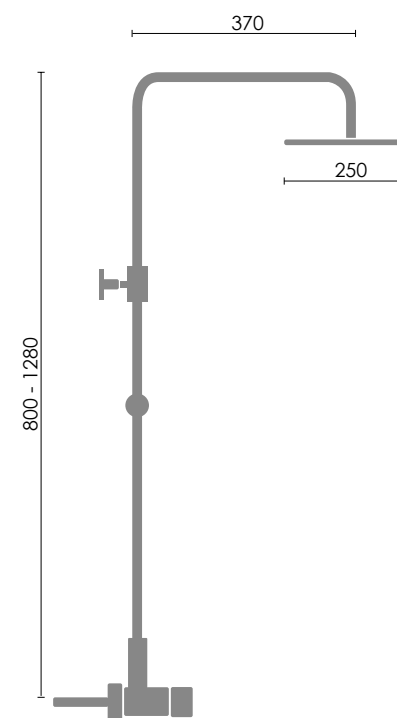

# Serie **KU**



## 121006

### Monomando lavabo alto / Basin mixer

Acabado cromo  
Cartucho 25 mm.

PVP: 118,00 €

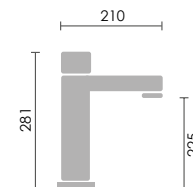

## 121001

### Monomando lavabo / Basin mixer

Acabado cromo  
Cartucho 25 mm.

PVP: 78,00 €

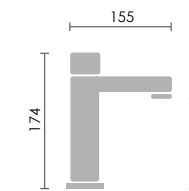

## 121002

### Monomando bidé / Bidet mixer

Acabado cromo  
Cartucho 25 mm.

PVP: 78,00 €

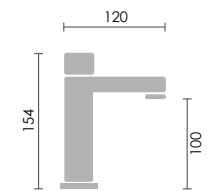

## 121003

### Monomando baño ducha / Bathtub mixer

Acabado cromo  
Cartucho 35 mm.

PVP: 145,00 €

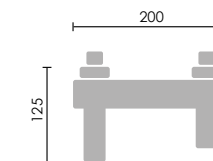

## 121004

### Monomando ducha / Shower mixer

Acabado cromo  
Cartucho 35 mm.

PVP: 111,00 €

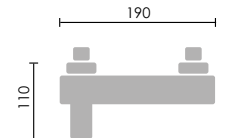

Incluido el kit de ducha. Flexo, mango de ducha y soporte.

**ACS WRAS KTW**  
APPROVED PRODUCT  
Cartuchos certificados.

# Serie **KU**



## **121009**

**Monomando lavabo empotrado / In wall basin mixer**

Acabado cromo  
Cartucho 35 mm.

**PVP: 125,00 €**

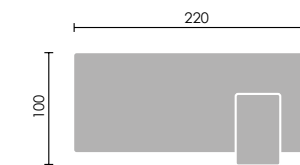

**Cuerpo en caja empotrable**  
Profundidad: 63 mm



# Serie **KU**

clausy bath

Criferia de  
**BANO**

**122026**

**Monomando cartucho 35 mm**

Barra extensible (de 800 a 1280 mm)  
Rociador antical acero 200x250 mm  
Flexo reforzado de 1,5-2,0  
Ducha modelo 150 - 1 posición  
Acabado cromo

**PVP: 260,00 €**

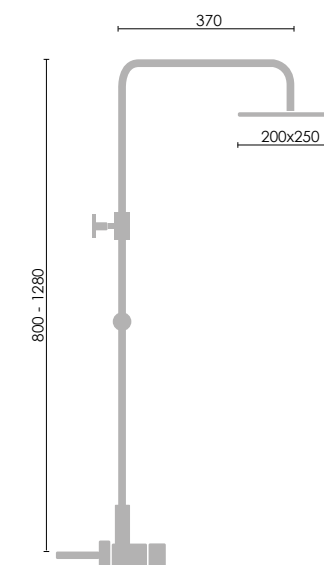

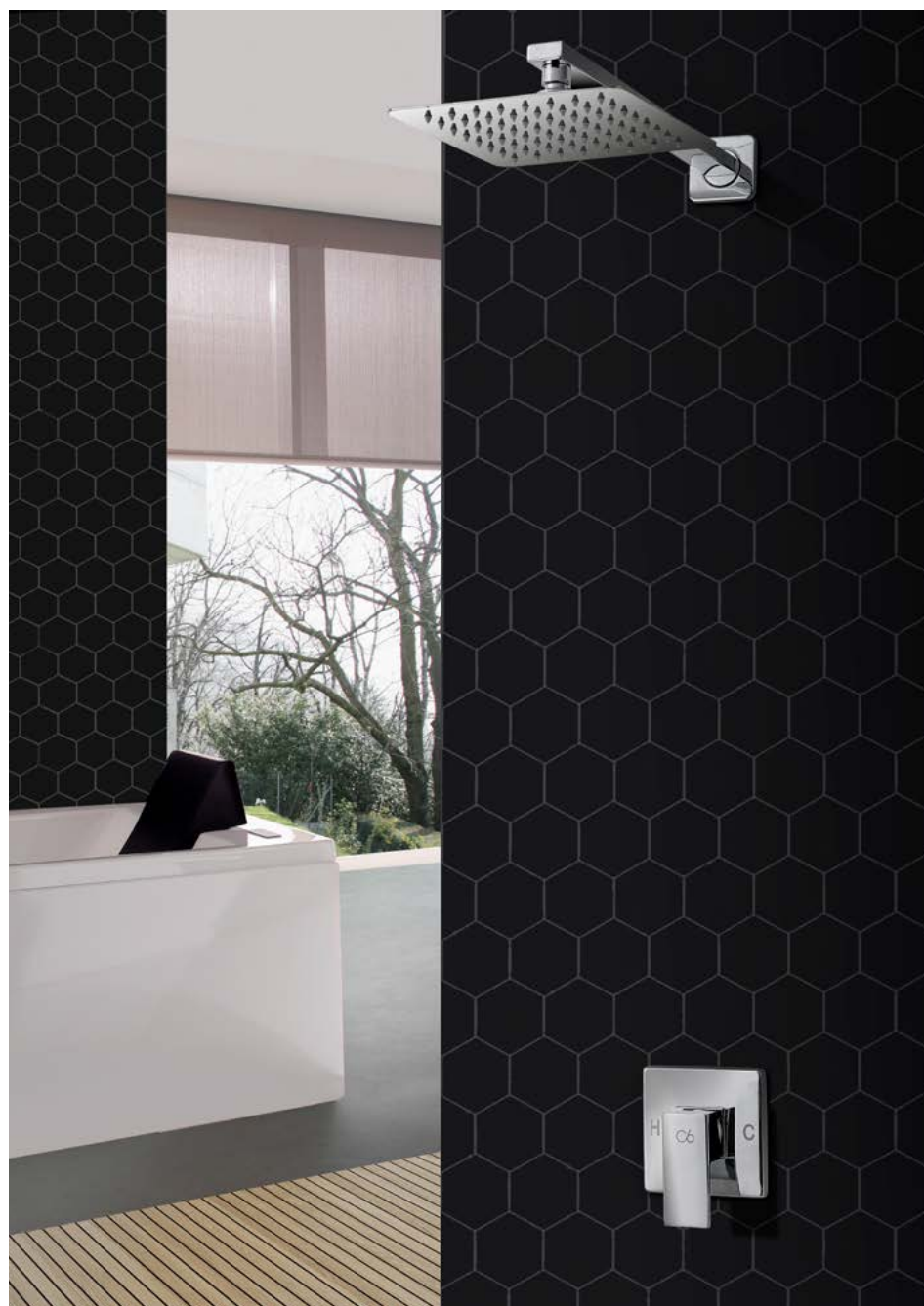

# Serie **KU** 1 Vía

**121012**

**Monomando empotrado de 1 vía**

Rociador antical acero de 200x200 mm  
Brazo de ducha de 1/2x37 cm

PVP: 128,00 €

**Cuerpo en caja empotrable**  
Profundidad: 63 mm



# Serie **KU** 2 Vía

**121013**

**Monomando empotrado de 2 vías con distribuidor**

Rociador antical acero de 200x200 mm  
Flexo y teléfono  
Brazo de ducha de 1/2x37 cm  
Codo de ducha con soporte

PVP: 225,00 €

**Cuerpo en caja empotrable**  
Profundidad: 63 mm





# Serie KU 3 Vía



**121007**

**Ducha empotrada / Built-in-mixer**

1 vía  
Acabado cromo

PVP: 80,00 €



**121008**

**Ducha empotrada / Built-in-mixer**

2 vías  
Acabado cromo

PVP: 110,00 €



**121015**

**Caño KU**

PVP: 39,00 €



**121132**

**Ducha empotrada / Built-in-mixer**

3 vías  
Acabado cromo

PVP: 135,00 €

**121014**

**Monomando empotrado de 3 vías**

Rociador antical acero de 200x200 mm  
Flexo y teléfono  
Brazo de ducha de 1/2  
Codo de ducha con soporte  
Caño de llenado

PVP: 290,00 €

**Cuerpo en caja empotrable**  
Profundidad: 63 mm



# Serie **KU** Negro

PVD



## 121001 NG

**Monomando lavabo** / Basin mixer

Acabado negro mate  
Cartucho 25 mm.

PVP: 90,00 €

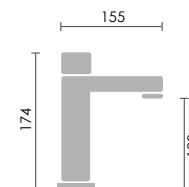

## 121001 NG

**Monomando lavabo alto** / Basin mixer

Acabado negro mate  
Cartucho 25 mm.

PVP: 136,00 €

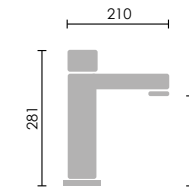

## 121002 NG

**Monomando bidé** / Bidet mixer

Acabado negro mate  
Cartucho 25 mm.

PVP: 90,00 €

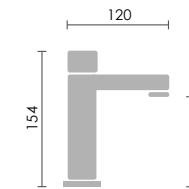

## 121009 NG

**Monomando lavabo empotrado**

/ In wall basin mixer

Acabado negro mate  
Cartucho 35 mm.

PVP: 145,00 €

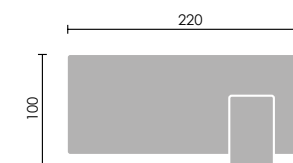

# Serie **KU** Negro

**122026 NG**

**Conjunto monomando**

Cartucho 35 mm  
 Barra extensible (de 800 a 1280 mm)  
 Rociador antical acero 200x250 mm  
 Flexo 1,7 PVC NEGRO  
 Ducha modelo 120 - 1 posición  
 Acabado negro mate

**PVP: 288,00 €**

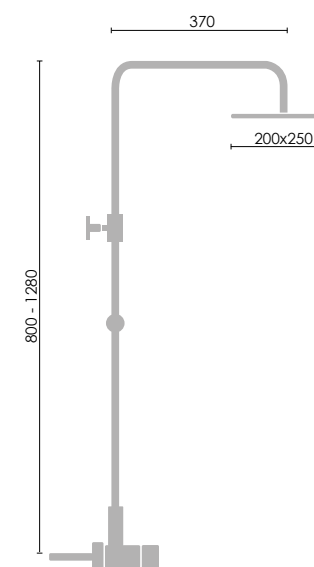

# Serie **KU** 2 Vía



## 121013NG

### Conjunto Monomando Empotrado 2 VIAS

Rociador antical acero SS304 de 250x250 mm  
 Monomando empotrado de 2 vías  
 Caja registrable  
 Brazo de ducha de 1/2x37 cm  
 Salida para flexo c/ soporte integrado  
 Flexo 1,7 PVC NEGRO  
 Ducha de 1 posición  
 Acabado: Negro

PVP: 275,00 €

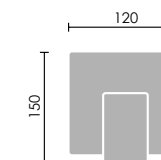

**Cuerpo en caja empotrable**  
 Profundidad: 63 mm



## 121008NG

### Grifo monomando empotrado 32 VIAS

Acabado negro  
 Incluye caja registrable  
 No incluye flexo ni mango de ducha

PVP: 145,00 €



# Serie **KU** 3 Vía

## 121014NG

### Conjunto Monomando Empotrado 3 VIAS

Rociador antical acero SS304 de 250x250 mm  
 Monomando empotrado de 3 vías  
 Caja registrable  
 Brazo de ducha de 1/2x37 cm  
 Salida para flexo c/ soporte integrado  
 Flexo reforzado cromado 1,70 PVC  
 Ducha de 1 posición  
 Acabado: Negro

PVP: 340,00 €

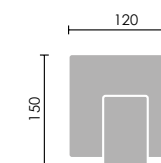

### Cuerpo en caja empotrable Profundidad: 63 mm



## 121132NG

### Grifo monomando empotrado 3 VIAS

Acabado negro  
 Incluye caja registrable  
 No incluye flexo ni mango de ducha

PVP: 185,00 €



## 121015NG

### Caño KU

Acabado negro

PVP: 51,00 €



# Serie CÍES



**121521**

**Monomando lavabo /** Basin mixer

Acabado cromo  
Cartucho 35 mm.

PVP: 74,00 €

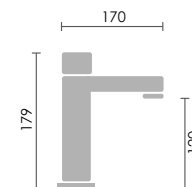

**121522**

**Monomando bidé /** Bidet mixer

Acabado cromo  
Cartucho 35 mm.

PVP: 74,00 €

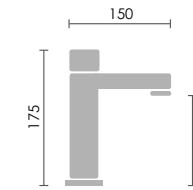

**121523**

**Monomando baño ducha /** Bathtub mixer

Acabado cromo  
Cartucho 35 mm.

PVP: 115,00 €

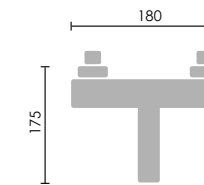

**121524**

**Monomando ducha /** Shower mixer

Acabado cromo  
Cartucho 35 mm.

PVP: 82,00 €

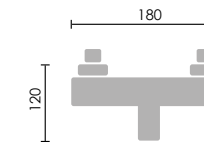

Incluido el kit de ducha. Flexo, mango de ducha y soporte.

**ACS WRAS KTW**  
APPROVED PRODUCT  
Cartuchos certificados.

# Serie **CÍES**

## 122014

### Monomando cartucho 35 mm

Barra extensible (de 870 a 1350 mm)  
Rociador antical acero 200x250 mm  
Flexo reforzado de 1,5-2,0  
Ducha modelo 150 - 1 posición  
Acabado cromo

PVP: 170,00 €

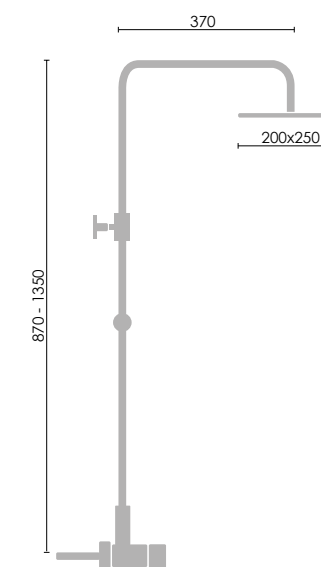

# Serie **VARTA**



**121421**

**Monomando lavabo /** Basin mixer

Acabado cromo  
Cartucho 35 mm.

PVP: 74,00 €

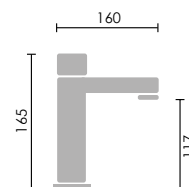

**121425**

**Monomando lavabo alto /** Basin mixer

Acabado cromo  
Cartucho 35 mm.

PVP: 115,00 €

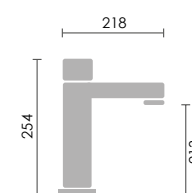

**121422**

**Monomando bidé /** Bidet mixer

Acabado cromo  
Cartucho 35 mm.

PVP: 74,00 €

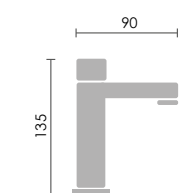

**121423**

**Monomando baño ducha /** Bathtub mixer

Acabado cromo  
Cartucho 35 mm.

PVP: 110,00 €

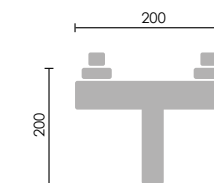

**121424**

**Monomando ducha /** Shower mixer

Acabado cromo  
Cartucho 35 mm.

PVP: 70,00 €

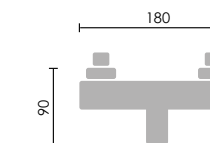

Incluido el kit de ducha. Flexo, mango de ducha y soporte.

**ACS WRAS KTW**  
APPROVED PRODUCT  
Cartuchos certificados.



# Serie **VARTA**

**122032**

**Conjunto monomando cartucho 35 mm**

Barra extensible (de 870 a 1350 mm)  
Rociador antical acero 250x250 mm  
Flexo reforzado de 1,5-2,0  
Ducha modelo 150 1 posición  
Acabado cromo

**PVP: 168,00 €**

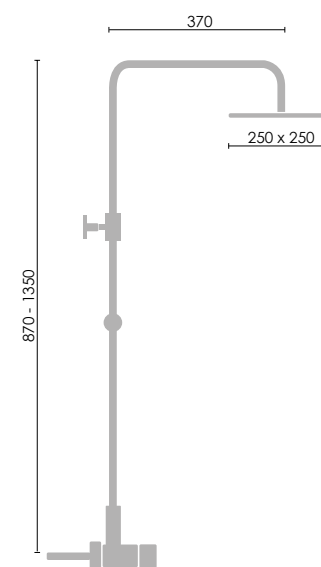

# Serie YDRA



**121201**  
**Monomando lavabo / Basin mixer**

Acabado cromo  
Cartucho 35 mm.

PVP: 74,00 €

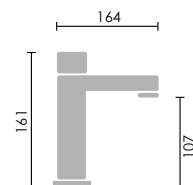

**121203**

**Monomando baño ducha / Bathtub mixer**

Acabado cromo  
Cartucho 35 mm.

PVP: 105,00 €

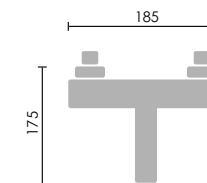

**121204**

**Monomando ducha / Shower mixer**

Acabado cromo  
Cartucho 35 mm.

PVP: 88,00 €

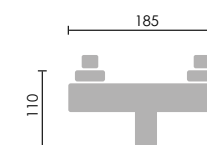

**121202**

**Monomando bidé / Bidet mixer**

Acabado cromo  
Cartucho 35 mm.

PVP: 74,00 €

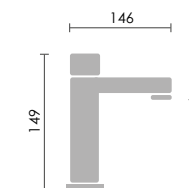

Incluido el kit de ducha. Flexo, mango de ducha y soporte.

**ACS WRAS KTW**  
APPROVED PRODUCT  
Cartuchos certificados.



# Serie **YDRA**

clausybath

Criferia de **BANO**

**122034**

## **Monomando cartucho 35 mm**

Barra extensible (de 870 a 1350 mm)  
Rociador antical acero 250 mm  
Flexo reforzado 1,5-2,0 m  
Ducha modelo 140 - 1 posición  
Acabado cromo

**PVP: 185,00 €**

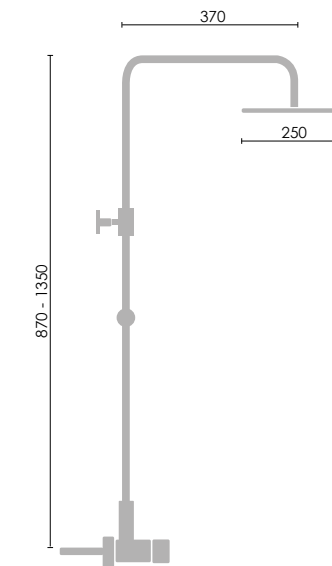

# Serie BONN



## 121107

### Monomando lavabo alto / Basin mixer

Acabado cromo  
Cartucho 35 mm.

PVP: 92,00 €

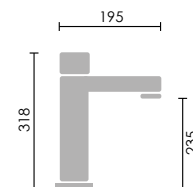

## 121101

### Monomando lavabo / Basin mixer

Acabado cromo  
Cartucho 35 mm.

PVP: 65,00 €

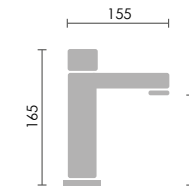

## 121102

### Monomando bidé / Bidet mixer

Acabado cromo  
Cartucho 35 mm.

PVP: 65,00 €

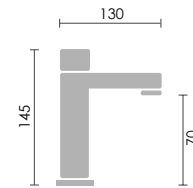

## 121104

### Monomando ducha / Shower mixer

Acabado cromo  
Cartucho 35 mm.

PVP: 88,00 €



## 121103

### Monomando baño ducha / Bathtub mixer

Acabado cromo  
Cartucho 35 mm.

PVP: 110,00 €

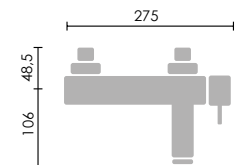

Incluido el kit de ducha. Flexo, mango de ducha y soporte.

ACS WRAS APPROVED PRODUCT KTW  
Cartuchos certificados.

# Serie **BONN**



**121111**

**Monomando lavabo empotrado / In wall basin mixer**

Acabado cromo  
Cartucho 35 mm.

**PVP: 115,00 €**

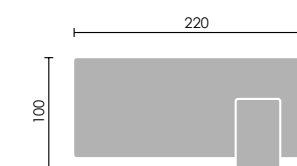

**Cuerpo en caja empotrable**  
Profundidad: 63 mm



## Serie **BONN** 1 Vía



## Serie **BONN** 2 Vías

**121119**

### Monomando empotrado de 1 vía

Rociador antical acero de 200 mm  
Brazo de ducha de 1/2x37 cm

PVP: 118,00 €

### Cuerpo en caja empotrable

Profundidad: 63 mm



**121120**

### Monomando empotrado de 2 vías con distribuidor

Rociador antical acero de 200 mm  
Flexo y teléfono  
Brazo de ducha de 1/2x37 cm  
Codo de ducha con soporte

PVP: 200,00 €

### Cuerpo en caja empotrable

Profundidad: 63 mm



# Serie **BONN** 3 Vías



**121121**

## Monomando empotrado de 3 vías con distribuidor

Rociador antical acero de 200 mm  
Flexo y teléfono  
Brazo de ducha de 1/2x37 cm  
Codo de ducha con soporte  
Caño de llenado

PVP: 250,00 €



**121110**

## Ducha empotrada con distribuidor / Built-in-mixer

2 vías  
Acabado cromo

PVP: 105,00 €



**121809**

## Ducha empotrada / Built-in-mixer

1 vía  
Acabado cromo

PVP: 69,00 €



**121122**

## Caño Bonn

PVP: 35,00 €



## Cuerpo en caja empotrable

Profundidad: 63 mm



**121131**

## Ducha empotrada con distribuidor / Built-in-mixer

3 vías  
Acabado cromo

PVP: 128,00 €



# Serie **BONN**

## 122011

### Conjunto monomando

- Cartucho 35 mm
- Barra extensible (de 870 a 1350 mm)
- Rociador antical acero 200 mm
- Flexo reforzado 1,5-2,0 m
- Ducha modelo 300 - 3 posiciones
- Acabado cromo

**PVP: 165,00 €**

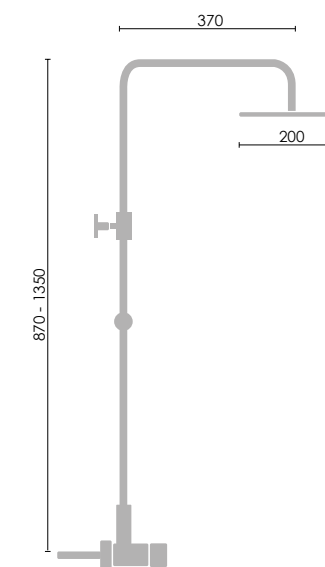

# Serie **KOBA**



**121801**

**Monomando lavabo / Basin mixer**

Acabado cromo  
Cartucho 35 mm.

PVP: 59,00 €

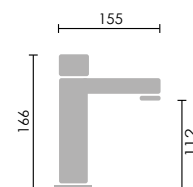

**121806**

**Monomando lavabo alto / Basin mixer**

Acabado cromo  
Cartucho 35 mm.

PVP: 98,00 €

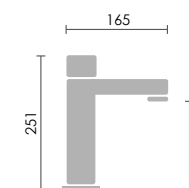

**121802**

**Monomando bidé / Bidet mixer**

Acabado cromo  
Cartucho 35 mm.

PVP: 59,00 €

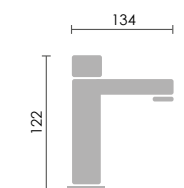

**121803**

**Monomando baño ducha / Bathtub mixer**

Acabado cromo  
Cartucho 35 mm.

PVP: 86,00 €

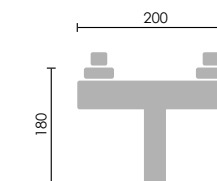

**121804**

**Monomando ducha / Shower mixer**

Acabado cromo  
Cartucho 35 mm.

PVP: 70,00 €

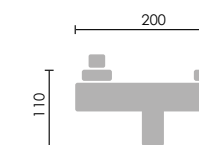

Incluido el kit de ducha. Flexo, mango de ducha y soporte.

**ACS WRAS KTW**  
APPROVED PRODUCT  
Cartuchos certificados.



# Serie **KOBA**

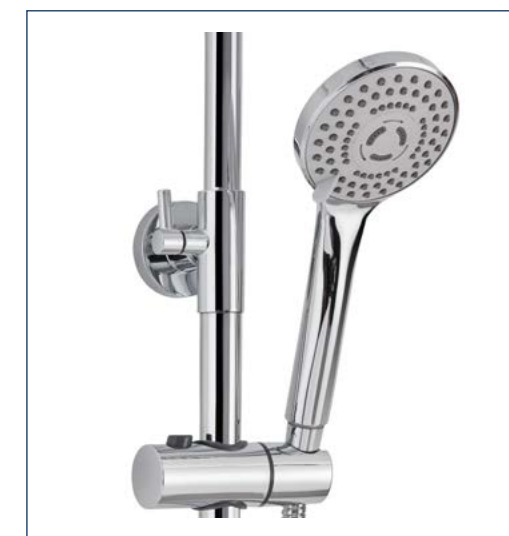

## 122029

### Conjunto monomando

Cartucho 35 mm  
 Barra extensible (de 870 a 1350 mm)  
 Rociador antical acero 250 mm  
 Flexo reforzado 1,5-2,0 m  
 Ducha de 3 posiciones modelo 300  
 Acabado cromo

PVP: 165,00 €

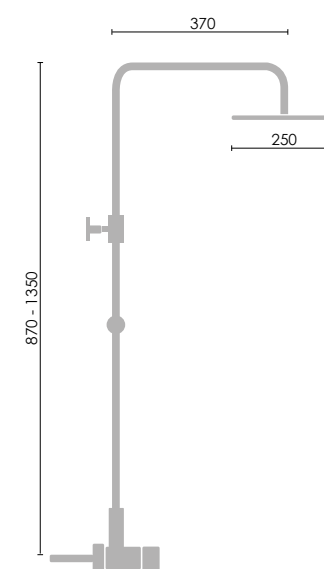



# Serie **KOBA II**

## 122036

### Conjunto monomando

Barra extensible de latón (de 800 a 1280 mm)  
 Rociador antical acero 250 mm  
 Flexo reforzado de 1,5-2,0 mm  
 Ducha de 3 posiciones modelo 300  
 Acabado cromo  
 Cartucho 35 mm  
 Apertura en frío

PVP: 192,00 €

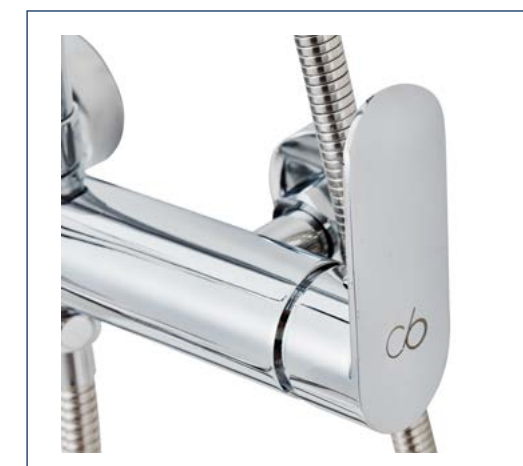
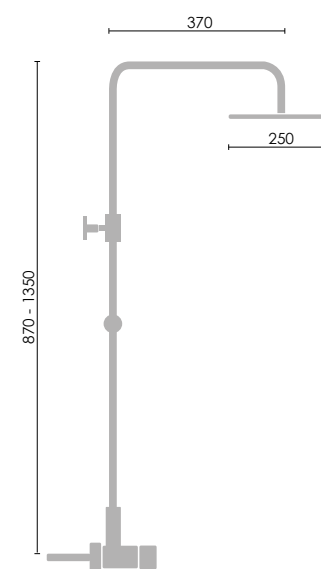

## 121814

### Monomando lavabo empotrado / In wall basin mixer

Acabado cromo  
 Cartucho 35 mm.

PVP: 110,00 €

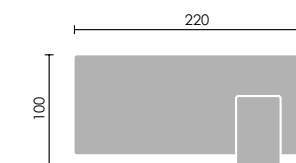

Incluido el kit de ducha. Flexo, mango de ducha y soporte.

**ACS WRAS KTW**  
 APPROVED PRODUCT  
 Cartuchos certificados.

# Serie **KOBA** Negro

PVD



## 121801 NG

**Monomando lavabo** / Basin mixer

Acabado negro mate  
Cartucho 35 mm

PVP: 74,00 €

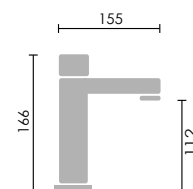

## 121802 NG

**Monomando bidé** / Bidet mixer

Acabado negro mate  
Cartucho 35 mm

PVP: 74,00 €

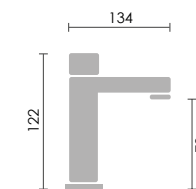

## 121806 NG

**Monomando lavabo alto** / Basin mixer

Acabado negro mate  
Cartucho 35 mm.

PVP: 115,00 €

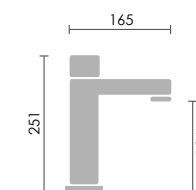

## 121814 NG

**Monomando lavabo empotrado**  
/ In wall basin mixer

Acabado negro mate  
Cartucho 35 mm.

PVP: 125,00 €

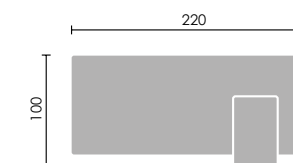

Incluido el kit de ducha. Flexo, mango de ducha y soporte.

**ACS WRAS KTW**  
Cartuchos certificados.

# Serie **KOBA** Negro

## 122029NG

### Conjunto monomando

Cartucho 35 mm  
 Barra extensible (de 870 a 1350 mm)  
 Rociador antical acero 250 mm  
 Flexo 1,7 PVC NEGRO  
 Ducha de 3 posiciones modelo 320  
 Acabado negro

**PVP: 195,00 €**

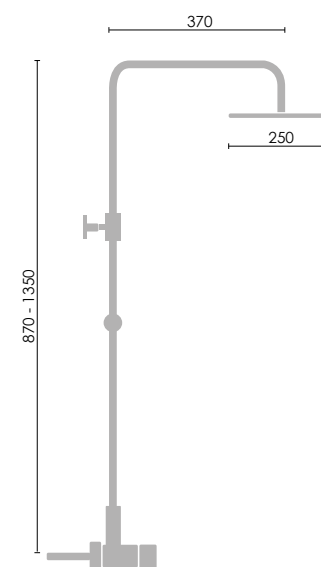

# Serie **KOBA** Negro



## 122036 NG

### Monomando

Barra extensible de latón (de 800 a 1280 mm)  
 Rociador antical acero 250 mm  
 Flexo 1,7 PVC NEGRO  
 Ducha de 5 posiciones modelo 320  
 Acabado negro  
 Cartucho 35 mm  
 Apertura en frío

**PVP: 235,00 €**

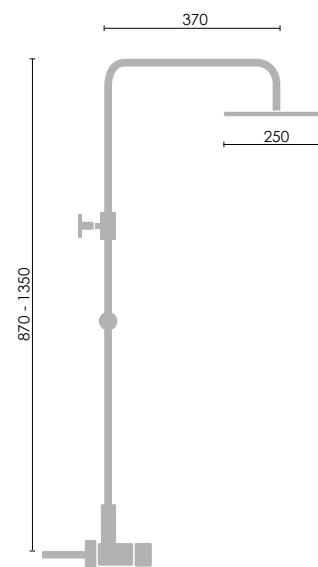

# Serie **KOBA** Oro

PVD



## 121814 OR

**Monomando lavabo empotrado/** In wall basin mixer

Acabado oro  
Cartucho 35 mm.

PVP: 130,00 €



## 121801 OR

**Monomando lavabo /** Basin mixer

Acabado oro  
Cartucho 35 mm.

PVP: 78,00 €

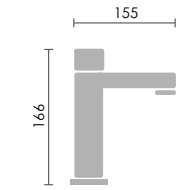

## 121802 OR

**Monomando bidé /** Bidet mixer

Acabado oro  
Cartucho 35 mm.

PVP: 78,00 €

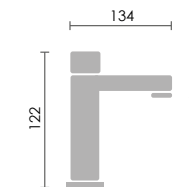

## 121806 OR

**Monomando lavabo alto /** Basin mixer

Acabado oro  
Cartucho 35 mm.

PVP: 120,00 €

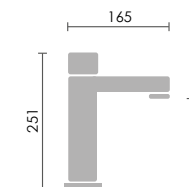

Incluido el kit de ducha. Flexo, mango de ducha y soporte.

**ACS WRAS** APPROVED PRODUCT **KTW**  
Cartuchos certificados.

# Serie **KOBA II** Oro



## **122036 OR**

### **Monomando**

Barra extensible de latón (de 800 a 1280 mm)  
 Rociador antical acero 250 mm  
 Flexo 1,7 PVC ORO  
 Ducha de 5 posiciones modelo 330  
 Acabado oro  
 Cartucho 35 mm  
 Apertura en frío

**PVP:268,00 €**

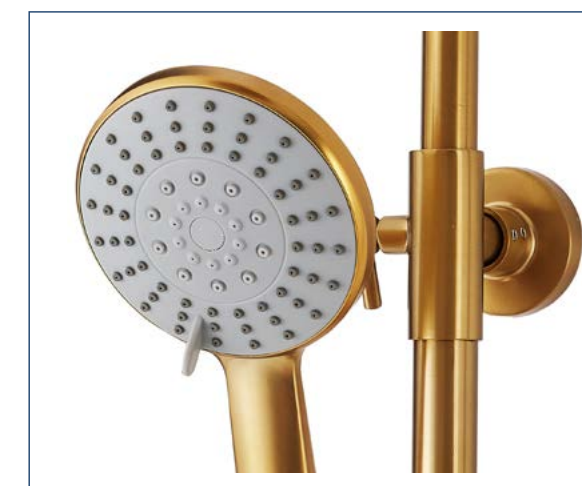
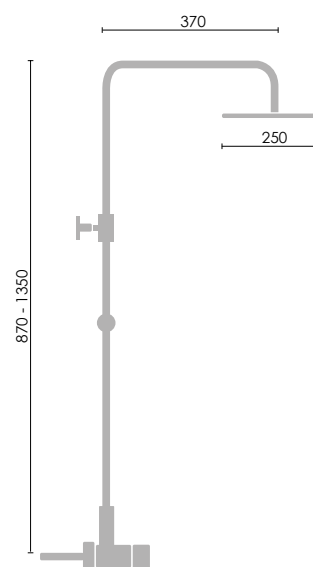

# Serie JADE



**121216**

**Monomando lavabo alto / Basin mixer**

Acabado cromo  
Cartucho 25 mm.

PVP: 95,00 €

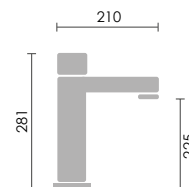

**121211**

**Monomando lavabo / Basin mixer**

Acabado cromo  
Cartucho 25 mm.

PVP: 53,00 €

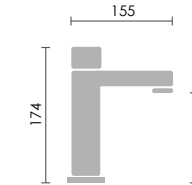

**121212**

**Monomando bidé / Bidet mixer**

Acabado cromo  
Cartucho 25 mm.

PVP: 53,00 €

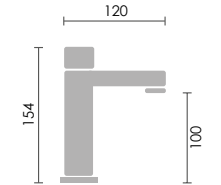

**121213**

**Monomando baño ducha / Bathtub mixer**

Acabado cromo  
Cartucho 35 mm.

PVP: 98,00 €

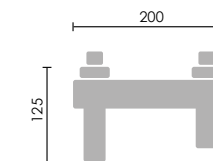

**121214**

**Monomando ducha / Shower mixer**

Acabado cromo  
Cartucho 35 mm.

PVP: 68,00 €

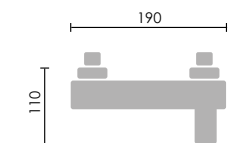

Incluido el kit de ducha. Flexo, mango de ducha y soporte.



# Serie **JADE**

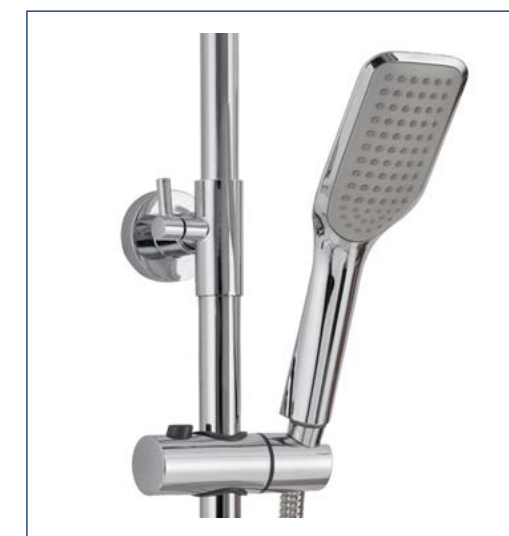

**122027**

**Monomando cartucho 35 mm**

Barra extensible (de 870 a 1350 mm)  
Rociador antical acero 200x250 mm  
Flexo reforzado 1,5-2,0 m  
Ducha modelo 140 - 1 posición  
Acabado cromo

**PVP: 160,00 €**

# Serie **JADE II**

**122021**

**Conjunto Monomando cartucho 35 mm**

Barra extensible (de 870 a 1350 mm)  
Rociador antical acero 250 mm  
Flexo reforzado de 1,5-2,0  
Ducha modelo 140 - 1 posición  
Acabado cromo

**PVP: 188,00 €**

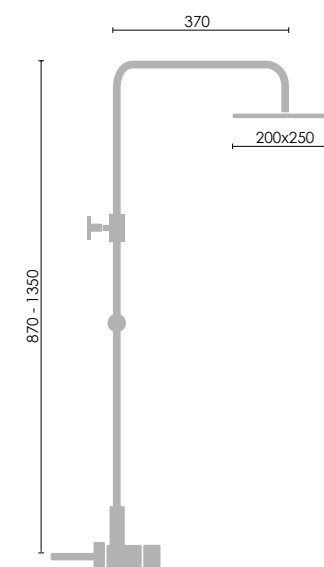

# Serie **JADE**



## **121221**

### **Conjunto Monomando**

Rociador antical acero SS304 de 250 mm  
 Monomando empotrado de 2 vías  
 Caja registrable  
 Brazo de ducha de 1/2x37 cm  
 Codo de ducha c/ soporte integrado  
 Flexo reforzado cromado 1,50-2,0 m.  
 Ducha de 3 posiciones  
 Acabado: Cromo

**PVP: 188,00 €**

## **121218**

### **Grifo monomando empotrado**

Acabado cromo  
 Incluye caja registrable  
 No incluye flexo ni mango de ducha

**PVP: 100,00 €**



No incluye flexo ni mango de ducha

# Serie **JADE** Negro

PVD



**121211NG**

**Monomando lavabo** / Basin mixer

Acabado negro  
Cartucho 25 mm.

PVP: 68,00 €

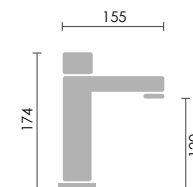

**121216NG**

**Monomando lavabo alto** / Basin mixer

Acabado negro  
Cartucho 25 mm.

PVP: 110,00 €

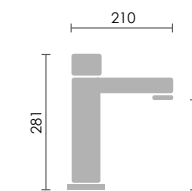

**121212NG**

**Monomando bidé** / Bidet mixer

Acabado negro  
Cartucho 25 mm.

PVP: 68,00 €

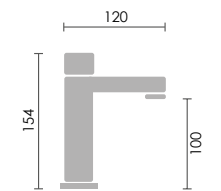

**121213NG**

**Monomando baño ducha** / Bathtub mixer

Acabado negro  
Cartucho 35 mm.

PVP: 122,00 €

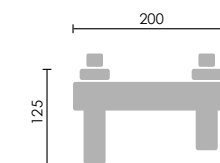

**121214NG**

**Monomando ducha** / Shower mixer

Acabado negro  
Cartucho 35 mm.

PVP: 89,00 €

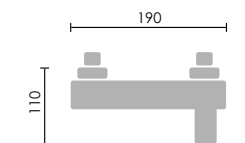

Incluido el kit de ducha. Flexo, mango de ducha y soporte.

# Serie **JADE** Negro

## 122021NG

### Conjunto Monomando

Rociador antical acero SS304 de 200 mm  
 Monomando empotrado de 2 vías  
 Caja registrable  
 Brazo de ducha de 1/2x37 cm  
 Salida para flexo c/ soporte integrado  
 Flexo PVC 1,7 m.  
 Ducha de 3 posiciones  
 Acabado: Negro mate

PVP: 225,00 €

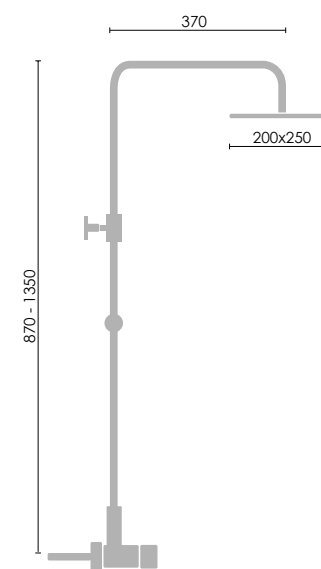

# Serie **JADE II** Negro

**122027NG**

**Conjunto Monomando cartucho 35 mm**

Barra extensible (de 870 a 1350 mm)  
 Rociador antical acero DE 200x250 mm  
 Flexo 1,7 PVC NEGRO  
 Ducha modelo 300 - 3 posición  
 Acabado negro

PVP: 208,00 €

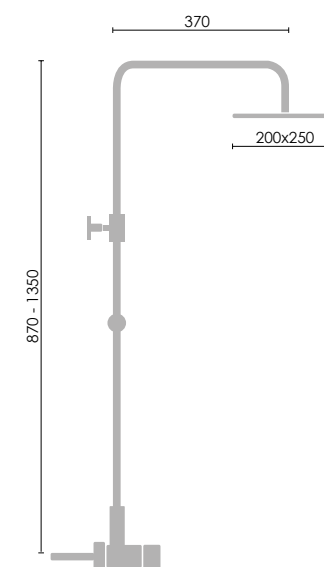

# Serie **JADE** Negro

## 121221NG

### Conjunto Monomando

Rociador antical acero SS304 de 250 mm  
 Monomando empotrado de 2 vías  
 Caja registrable  
 Brazo de ducha de 1/2x37 cm  
 Codo de ducha c/ soporte integrado  
 Flexo 1,7 PVC NEGRO  
 Ducha de 3 posiciones  
 Acabado: negro

PVP: 225,00 €

## 121218NG

### Grifo monomando empotrado

Acabado negro  
 Incluye caja registrable  
 No incluye flexo ni mango de ducha

PVP: 120,00 €

No incluye flexo ni mango de ducha



# Serie ZURICH



**121911**

**Monomando lavabo / Basin mixer**

Acabado cromo  
Cartucho 35 mm.

PVP: 44,00 €

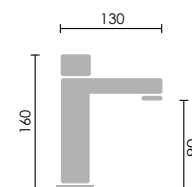

**121912**

**Monomando bidé / Bidet mixer**

Acabado cromo  
Cartucho 35 mm.

PVP: 44,00 €

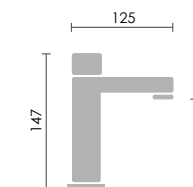

**121913**

**Monomando baño ducha / Bathtub mixer**

Acabado cromo  
Cartucho 35 mm.

PVP: 80,00 €

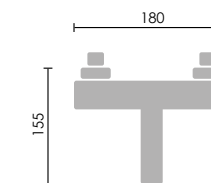

**121914**

**Monomando ducha / Shower mixer**

Acabado cromo  
Cartucho 35 mm.

PVP: 61,00 €

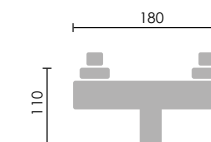

Incluido el kit de ducha. Flexo, mango de ducha y soporte.

**ACS WRAS KTW**  
APPROVED PRODUCT  
Cartuchos certificados.



## Serie **ZURICH** Redondo

**122019**

### **Rociador redondo**

Barra extensible (de 870 a 1350 mm)  
Rociador antical acero 200 mm  
Flexo reforzado 1.5-2.0 m  
Ducha modelo 300 - 3 posición  
Acabado cromo

**PVP: 152,00 €**



## Serie **ZURICH** Cuadrado

**122025**

### **Rociador cuadrado**

Barra extensible (de 870 a 1350 mm)  
Rociador antical acero 200x200 mm  
Flexo reforzado 1.5-2.0 m  
Ducha modelo 150 - 1 posición  
Acabado cromo

**PVP: 155,00 €**



# Serie ALFA



## 121301

### Monomando lavabo / Basin mixer

Acabado cromo  
Cartucho 40 mm.

PVP: 34,00 €

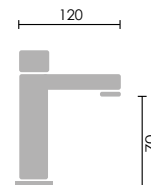

## 121302

### Monomando bidé / Bidet mixer

Acabado cromo  
Cartucho 40 mm.

PVP: 34,00 €

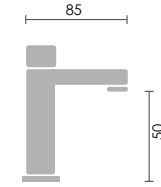

## 121303

### Monomando baño ducha / Bathtub mixer

Acabado cromo  
Cartucho 40 mm.

PVP: 65,00 €



## 121304

### Monomando ducha / Shower mixer

Acabado cromo  
Cartucho 40 mm.

PVP: 50,00 €



Incluido el kit de ducha. Flexo, mango de ducha y soporte.

ACS WRAS APPROVED PRODUCT KTW  
Cartuchos certificados.

# Serie CLASSIC Cromo



**121401**

**Monobloc lavabo / Mono basin mixer**

Acabado cromo  
Montura cerámica 1/4 v

PVP: 98,00 €

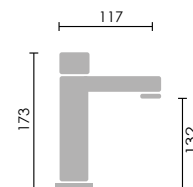

**121402**

**Monobloc bidé / Mono bidet mixer**

Acabado cromo  
Montura cerámica 1/4 v

PVP: 98,00 €

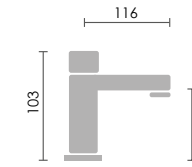

**121403**

**Monobloc baño ducha / Bathtub mixer**

Acabado cromo  
Montura cerámica 1/4 v

PVP: 145,00 €

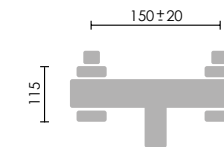

**121404**

**Monobloc ducha / Shower mixer**

Acabado cromo  
Montura cerámica 1/4 v

PVP: 88,00 €

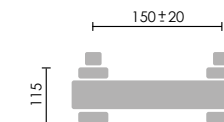

Incluido el kit de ducha. Flexo, mango de ducha y soporte.

# Serie **CLASSIC** Cromo

## 122015

### Grifería bimando montura cerámica 1/4 v

Barra extensible (de 870 a 1350 mm)  
 Rociador antical acero 200 mm  
 Flexo reforzado 1,5-2,0 m  
 Ducha classic - 1 posición  
 Acabado cromo

PVP: 295,00 €

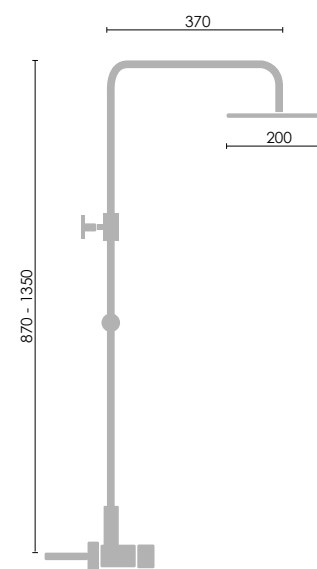

# Serie CLASSIC Bronce



**121411**

**Monobloc lavabo / Mono basin mixer**

Acabado bronce  
Montura cerámica 1/4 v

PVP: 115,00 €

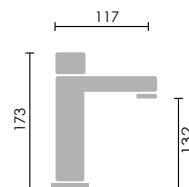

**121412**

**Monobloc bidé / bidet mixer**

Acabado bronce  
Montura cerámica 1/4 v

PVP: 115,00 €

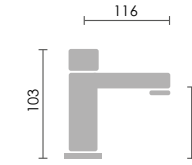

**121413**

**Monobloc baño ducha / Bathtub mixer**

Acabado bronce  
Montura cerámica 1/4 v

PVP: 175,00 €

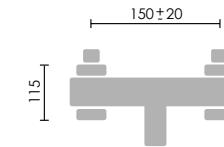

**121414**

**Monobloc ducha / Shower mixer**

Acabado bronce  
Montura cerámica 1/4 v

PVP: 114,00 €

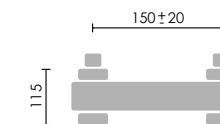

Incluido el kit de ducha. Flexo, mango de ducha y soporte.

# Conjuntos de DUCHA

■ Serie ÁRTICO	158 / 159
■ Serie ÁRTICO NEGRO	160 / 161
■ Serie BANI	162 / 163
■ Serie BAN NEGRO I	164 / 165
■ Serie ÍNDICO	166 / 167
■ Serie ÍNDICO NEGRO	168 / 169
■ Serie ÍNDICO ORO	170 / 171 /
■ Serie ÍNDICO ROSA	172 / 173
■ Serie ÍNDICO GRIS METAL	174 / 175
■ Serie ÍNDICO BLANCO	176 / 177
■ Serie ANDROS	178 / 179
■ Serie TERES	180 / 181
■ Serie INDO	182 / 183
■ Serie INDO NEGRO	184 / 185
■ Serie KRONOS	186 / 187
■ Serie KRONOS NEGRO	188 / 189
■ Serie COOPER	190 / 191
■ Serie COOPER NEGRO	192 / 193
■ Serie OLIMPIC	194
■ Serie TITANIC	195

# Serie **ÁRTICO**

## 122004

### Conjunto Termostático Cartucho Cítec

Barra extensible de latón (de 870 a 1280 mm)  
Rociador antical acero 200x250 mm  
Flexo y teléfono modelo 150  
Acabado cromo  
Volantes metálicos

PVP: 290,00 €

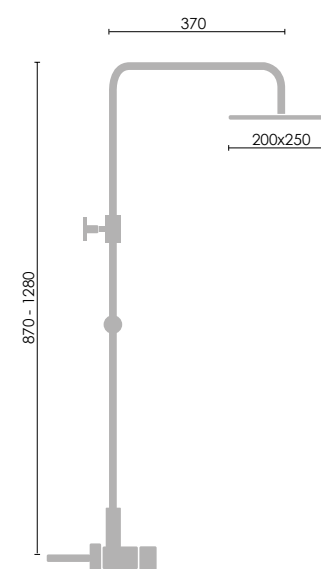



# Serie **ÁRTICO** Negro

PVD

## 122004 NG

### Conjunto Termostático Cartucho Cítec

Barra extensible de latón (de 870 a 1280 mm)  
Rociador antical acero 200x250 mm  
Flexo y teléfono  
Acabado negro  
Volantes metálicos

PVP: 320,00 €

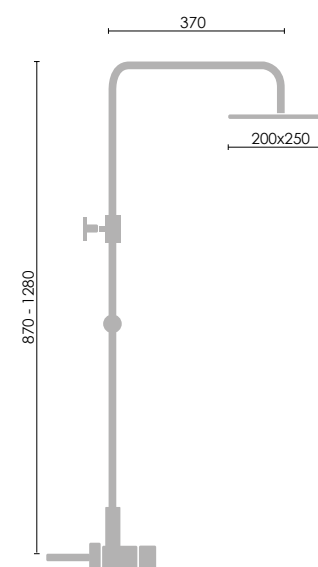

# Serie **BANI**

**122037**

## Conjunto Termostático Cartucho Citec

Barra extensible de latón (de 870 a 1280 mm)  
Rociador antical acero 200x250 mm  
Flexo y teléfono modelo 150  
Acabado cromo  
Volantes metálicos

PVP: 240,00 €

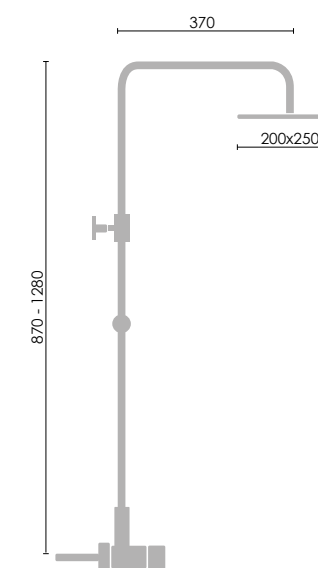

# Serie **BANI** Negro

## 122037 NG

### Conjunto Termostático Cartucho Citec

Barra extensible de latón (de 870 a 1280 mm)  
Rociador antical acero 200x250 mm  
Flexo y teléfono  
Acabado negro  
Volantes metálicos

PVP: 265,00 €

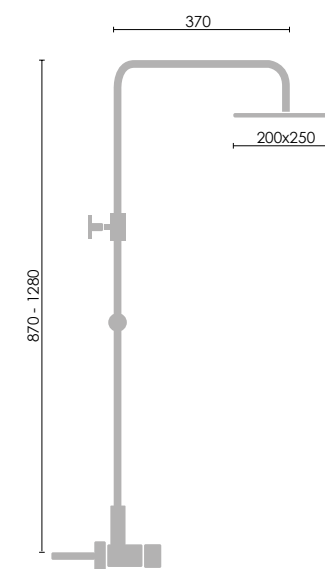

# Serie **ÍNDICO**

## 122003

### Conjunto Termostático Cartucho Cítec

Barra extensible de latón (de 800 a 1280 mm)  
Rociador antical acero 250 mm  
Flexo reforzado 1,5-2,0 m  
Ducha de 5 posiciones modelo 500  
Acabado cromo  
Volantes metálicos

PVP: 225,00 €

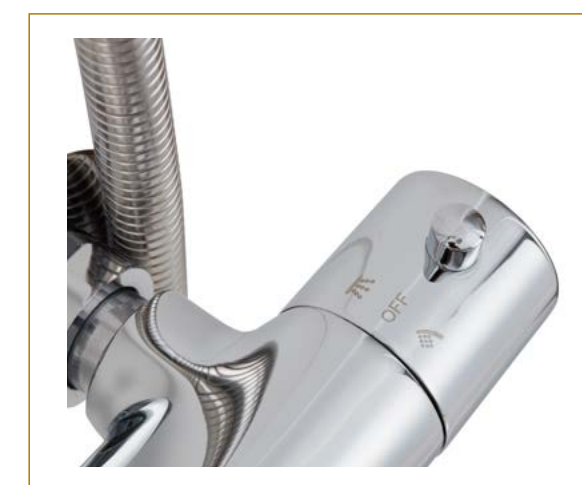
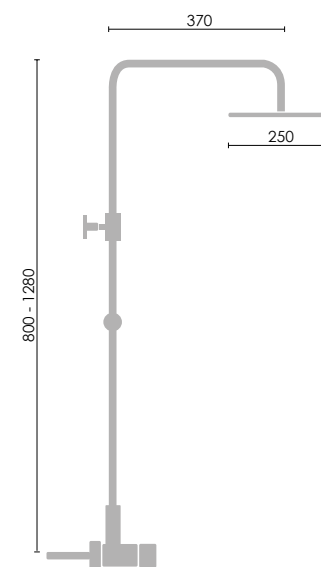

# Serie **ÍNDICO** Negro

PVD



## 122003 NG

### Conjunto Termostático Cartucho Citec

Barra extensible de latón (de 800 a 1280 mm)  
 Rociador antical acero 250 mm  
 Flexo 1,7 PVC NEGRO  
 Ducha de 5 posiciones modelo 320  
 Acabado negro  
 Volantes metálicos

PVP: 245,00 €

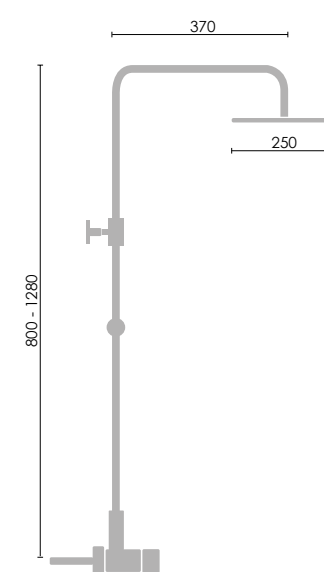

# Serie **ÍNDICO** oro

PVD

**122003OR****Conjunto Termostático  
Cartucho Citec**

Barra extensible de latón (de 800 a 1280 mm)  
 Rociador antical acero 250 mm  
 Flexo 1,7 PVC ORO  
 Ducha de 5 posiciones modelo 330  
 Acabado oro cepillado  
 Volantes metálicos

**PVP: 310,00 €**

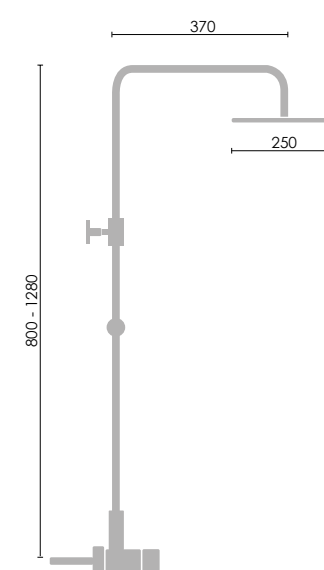

# Serie **ÍNDICO** rosa

PVD

**122003RC****Conjunto Termostático  
Cartucho Cítec**

Barra extensible de latón (de 800 a 1280 mm)  
 Rociador antical acero 250 mm  
 Flexo 1,7 PVC ROSA  
 Ducha de 5 posiciones modelo 360  
 Acabado rosa cepillado  
 Volantes metálicos

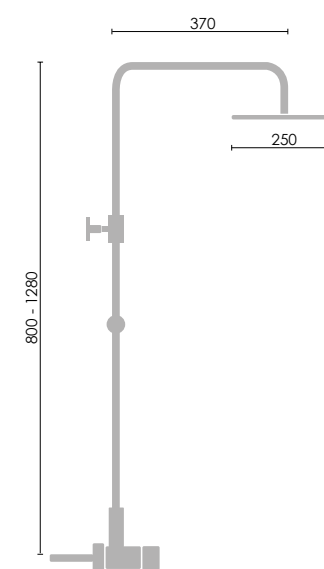
**PVP: 320,00 €**

# Serie **ÍNDICO** Gris metal PVD



## 122003GM

### Conjunto Termostático Cartucho Cítec

Barra extensible de latón (de 800 a 1280 mm)  
Rociador antical acero 250 mm  
Flexo 1,7 PVC GRIS  
Ducha de 5 posiciones modelo 320  
Acabado gris metal  
Volantes metálicos

PVP: 320,00 €

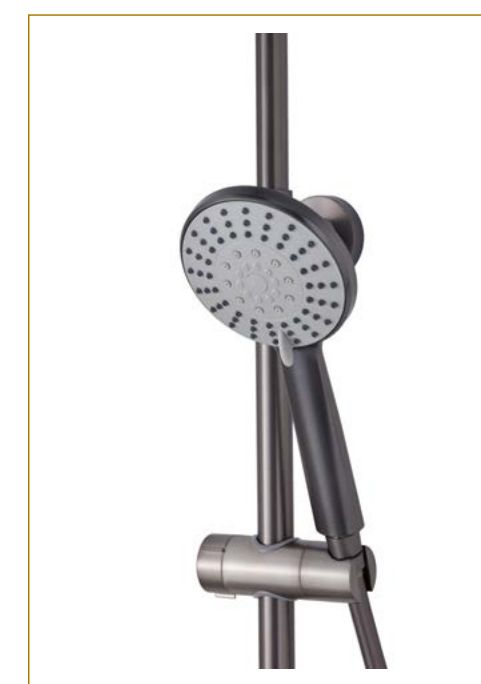
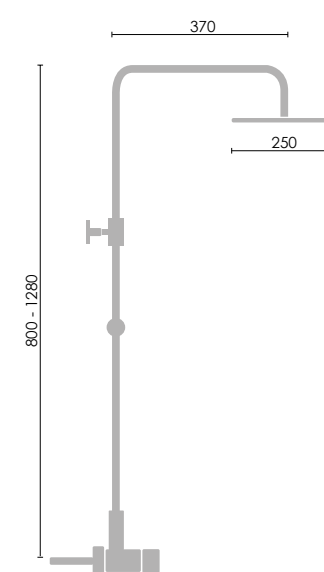

# Serie **ÍNDICO** Blanco

## 122003 BL

### Conjunto Termostático Cartucho Citec

Barra extensible de latón (de 800 a 1280 mm)  
Rociador antical acero 250 mm  
Flexo 1,7 PVC BLANCO  
Ducha de 5 posiciones modelo 340  
Acabado blanco  
Volantes metálicos

**PVP: 245,00 €**

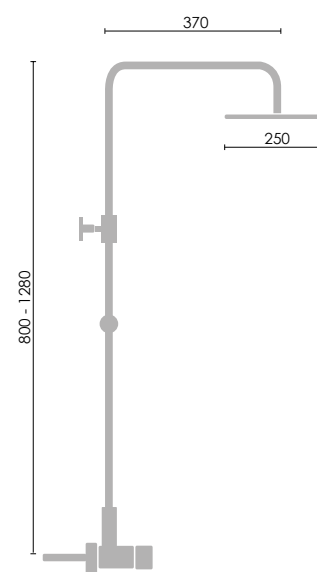

# Serie **ANDROS**

**122017**

**Conjunto Termostático  
Cartucho Citec**

Barra extensible de latón (de 800 a 1280 mm)  
Rociador antical acero 200 mm  
Flexo reforzado 1,5-2,0 m  
Ducha de 3 posiciones modelo 300  
Acabado cromo  
Volantes ABS

**PVP: 198,00 €**

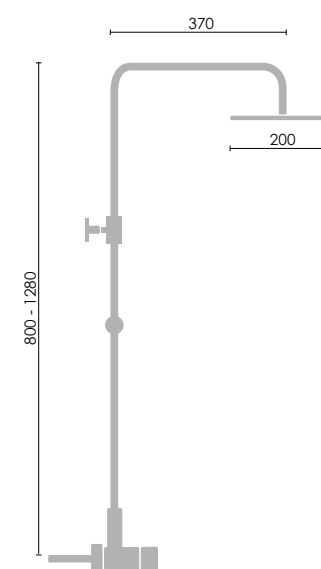

# Serie **TERES** Bañera



**122028**

## Conjunto Termostático de bañera

Barra extensible (de 1100 a 1500 mm)  
Rociador antical acero 250 mm  
Flexo reforzado 1,5-2,0 m  
Ducha de 3 posiciones modelo 300  
Acabado cromo

PVP: 295,00 €

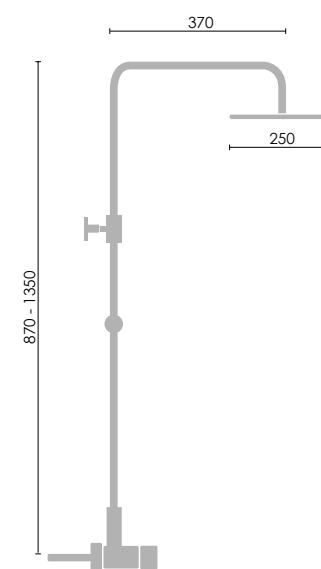

Inversor incorporado en la grifería



# Serie **INDO**

**122031**

## Conjunto monomando

Barra extensible de latón (de 870 a 1350 mm)  
 Rociador antical acero 200x250 mm  
 Flexo reforzado de 1,5-2,0 m  
 Ducha de 1 posición modelo 150  
 Acabado cromo  
 Cartucho 35 mm

**PVP: 168,00 €**

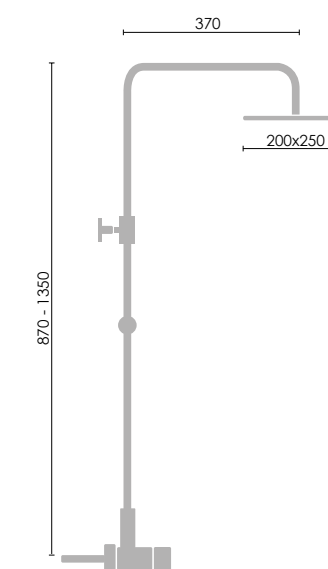

# Serie **INDO** Negro



## 122031 NG

### Conjunto monomando

Barra extensible (de 870 a 1350 mm)  
 Rociador antical acero 200x250 mm  
 Flexo 1,7 PVC NEGRO  
 Ducha de 1 posición  
 Acabado negro  
 Cartucho 35 mm

PVP: 186,00 €

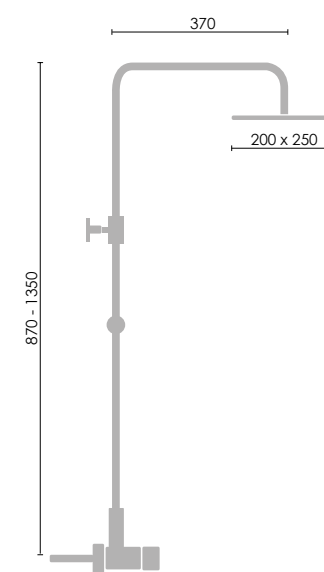

# Serie **KRONOS**

## 122002

### Conjunto monomando

Barra extensible de latón (de 800 a 1280 mm)  
 Rociador antical acero 250 mm  
 Flexo reforzado de 1,5-2,0 mm  
 Ducha de 3 posiciones modelo 300  
 Acabado cromo  
 Cartucho 35 mm  
 Apertura en frío

PVP: 195,00 €

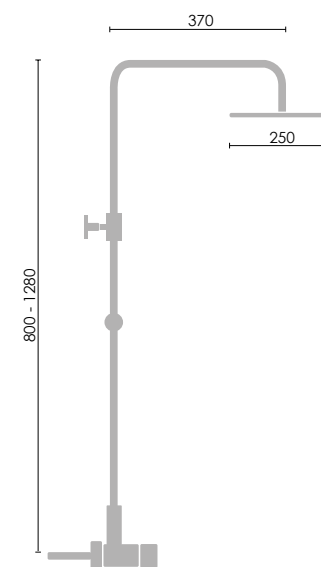

## 121114

### Monomando de ducha

PVP: 85,00 €



# Serie **KRONOS** Negro

PVD

**122002 NG****Conjunto monomando**

Barra extensible de latón (de 800 a 1280 mm)  
 Rociador antical acero 250 mm  
 Flexo 1,7 PVC NEGRO  
 Ducha de 5 posiciones modelo 320  
 Acabado negro  
 Cartucho 35 mm  
 Apertura en frío

PVP: 230,00 €

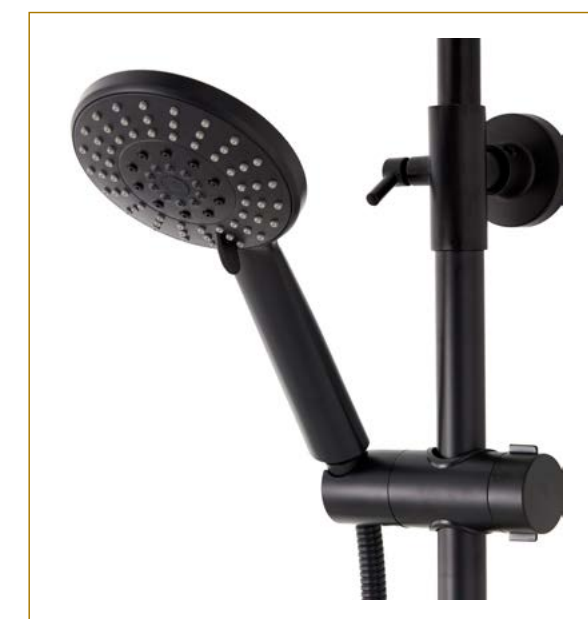
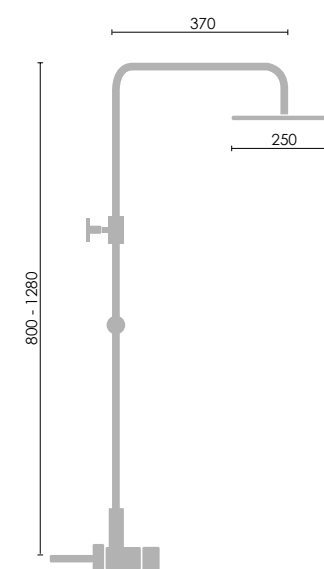

# Serie **COOPER** Bañera



## 122033

### Conjunto monomando bañera

Barra extensible (de 1000 a 1550 mm)  
Rociador acero 200x250 mm  
Flexo reforzado de 1,5-2,0 m  
Ducha de 1 posición modelo 150  
Acabado cromo

PVP: 285,00 €

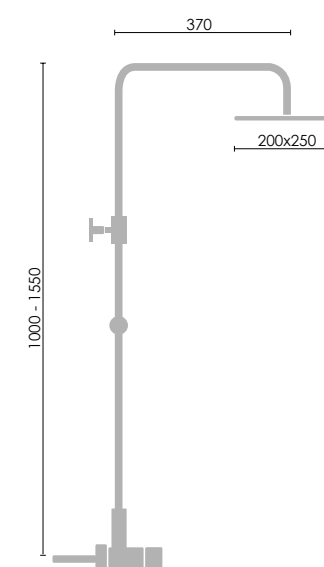

# Serie **COOPER** Negro

**122033NG**

## Conjunto Monomando BAÑERA

Cartucho 35 mm  
 Barra extensible (de 870 a 1550 mm)  
 Distribuidor cerámico  
 Rociador antical acero 250 mm  
 Flexo 1,7 PVC NEGRO  
 Ducha modelo 300 - 3 posición  
 Acabado: Negro

**PVP: 320,00 €**

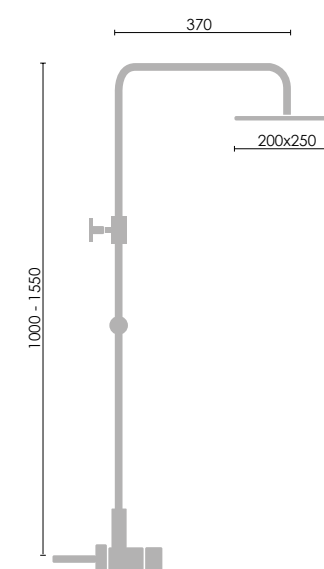

# Serie **OLIMPIC**



**122022**

## Conjunto de barra, rociador y ducha

Tubo telescópico de 700 a 1180 mm  
 Barra  $\phi$ 25 mm  
 Distribuidor, soporte ajustable  
 Flexo de 1,7 m. y conexión de 0,70 m  
 Rociador de acero  
 Ducha de 3 posiciones

**PVP: 118,00 €**

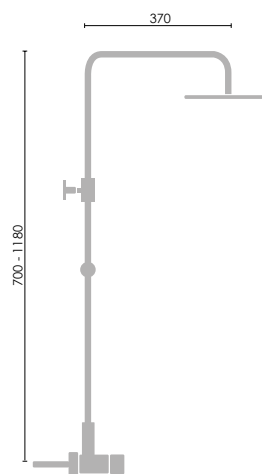

# Serie **TITANIC**



**122023**

## Conjunto de barra, rociador y ducha

Tubo telescópico de 800 a 1280 mm  
 Barra  $\phi$ 25 mm  
 Distribuidor, soporte ajustable  
 Flexo de 1,7 m. y conexión de 0,70 m  
 Rociador de 200x200 mm  
 Ducha de 1 posición

**PVP: 118,00 €**

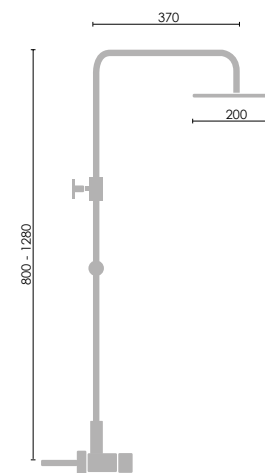

# Conjuntos EMPOTRADOS

■ Serie TÍBER	198 / 199
■ Serie TÍBER NEGRO	200 / 201
■ Serie GOBI	202 / 203
■ Serie ARAS	204 / 205
■ Serie ARAS NEGRO	206 / 207
■ Serie ARAS ORO	208 / 209
■ Serie CUBE	210 / 211
■ Serie CUBE NEGRO	212 / 213
■ Serie Bol	214 / 215
■ Serie KRABI	216 / 217
■ Serie KRABI NEGRO	218 / 219
■ Serie KRABI ORO	220 / 221
■ Serie KRABI ROSA	222 / 223
■ Serie KRABI GRIS METAL	224 / 225

# Serie TÍBER

## 121024

### Conjunto monomando empotrado

Rociador antical acero SS304 de 250x250 mm  
 Monomando empotrado de 2 vías  
 Caja registrable  
 Brazo de ducha de 1/2x37 cm  
 Salida para flexo c/ soporte integrado  
 Flexo reforzado cromado 1,50-2,0 m.  
 Ducha de 1 posición  
 Acabado: Cromo

PVP: 255,00 €

## 121030

### Grifo monomando empotrado cromo

Incluye caja registrable  
 No incluye flexo ni mango de ducha

PVP: 160,00 €

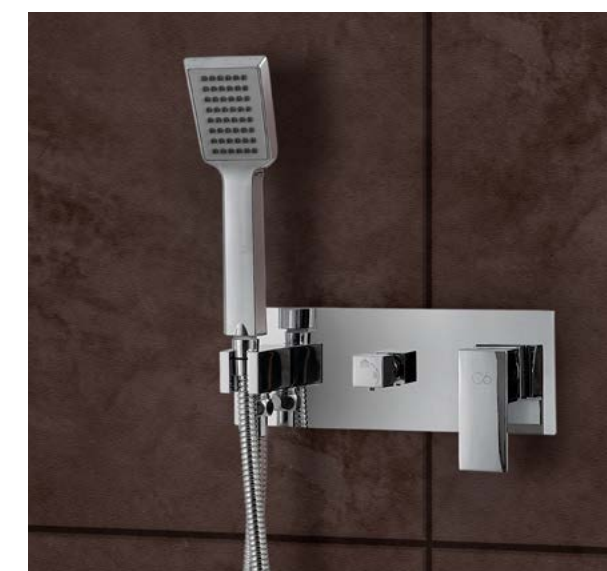
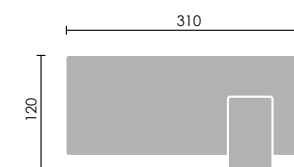

# Serie **TÍBER** Negro

PVD

## 121024 NG

### Conjunto monomando empotrado de 2 vías

Caja registrable  
 Rociador antical acero SS304 de 250x250 mm  
 Brazo de ducha de 1/2x37 cm  
 Salida para flexo con soporte integrado  
 Flexo 1.7 PVC NEGRO  
 Ducha de 1 posición  
 Acabado: Negro mate

PVP: 310,00 €

## 121030NG

### Grifo monomando empotrado negro mate

Incluye caja registrable  
 No incluye flexo ni mango de ducha

PVP: 188,00 €

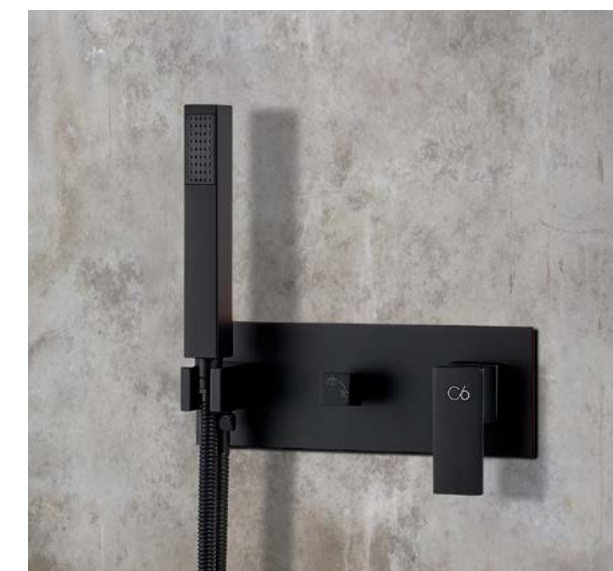
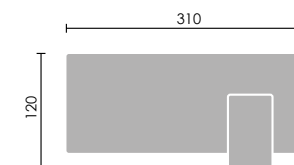

# Serie GOBI

## 121021

### Conjunto monomando empotrado de 2 vías

Caja registrable  
 Incluye premarco de acero SS304  
 Salida para flexo c/soporte integrado  
 Flexo reforzado cromado 1,50-2,0 m  
 Ducha de 1 posición  
 Acabado cromo  
 Rociador antical acero SS304 de 300x300 mm

PVP: 330,00 €

## 121021 - 40

Rociador antical acero SS304 de 400x400 mm

PVP: 365,00 €

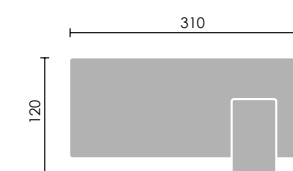

# Serie **ARAS**

## 121135

### Conjunto monomando empotrado

Rociador antical acero SS304 de 250 mm  
 Monomando empotrado de 2 vías  
 Caja registrable  
 Brazo de ducha de 1/2x37 cm  
 Salida para flexo c/ soporte integrado  
 Flexo reforzado cromado 1,50-2,0 m.  
 Ducha de 3 posiciones  
 Acabado: Cromo

PVP: 230,00 €

## 121140

### Grifo monomando empotrado cromo

Incluye caja registrable  
 No incluye flexo ni mango de ducha

PVP: 160,00 €

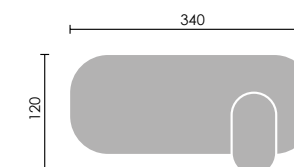

# Serie **ARAS** Negro

PVD

## 121135 NG

### Conjunto monomando empotrado de 2 vías

Caja registrable  
 Rociador antical acero SS304 de 250 mm  
 Brazo de ducha de 1/2x37 cm  
 Salida para flexo con soporte integrado  
 Flexo 1,7 PVC NEGRO  
 Ducha de 5 posiciones  
 Acabado: Negro mate

PVP: 295,00 €

## 121140NG

### Grifo monomando empotrado negro mate

Incluye caja registrable  
 No incluye flexo ni mango de ducha

PVP: 185,00 €

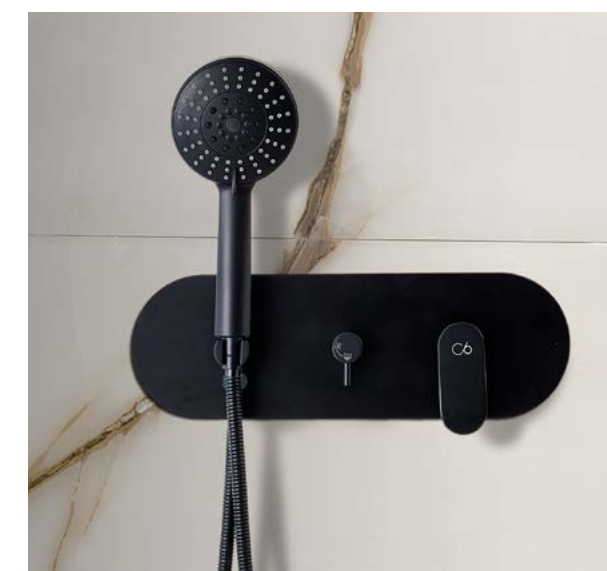
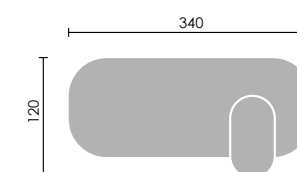



# Serie **ARAS** Oro

PVD

## 121135OR

### Conjunto monomando empotrado de 2 vías

- Caja registrable
- Rociador antical acero SS304 de 250 mm
- Brazo de ducha de 1/2x37 cm
- Salida para flexo con soporte integrado
- Flexo 1,7 PVC ORO
- Ducha de 5 posiciones
- Acabado: Oro

PVP: 345,00 €

## 121140OR

### Grifo monomando empotrado oro cepillado

- Incluye caja registrable
- No incluye flexo ni mango de ducha

PVP: 194,00 €

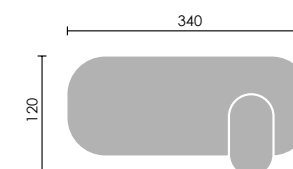

# Serie **CUBE**

## **121611**

### **Conjunto termostático empotrado de 2 vías**

Rociador antical acero de 200x200 mm  
Brazo de ducha de 1/2  
Codo de ducha con soporte

PVP: 310,00 €

## **121613**

### **Grifo termostático empotrado**

PVP: 170,00 €

### **Cuerpo en caja empotrable**

Profundidad: 63 mm



# Serie **CUBE** Negro

PVD



## 121611NG

### Conjunto termostático empotrado de 2 vías

Rociador antical acero de 200x200 mm  
 Brazo de ducha de 1/2  
 Codo de ducha con soporte

PVP: 375,00 €

## 121613

### Grifo termostático empotrado

PVP: 210,00 €

### Cuerpo en caja empotrable

Profundidad: 63 mm



# Serie **BOL**

## 121610

### Termostático empotrado de 2 vías

Rociador antical acero de 200 mm  
 Brazo de ducha de 1/2x37 cm  
 Codo de ducha con soporte

PVP: 290,00 €

## 121612

### Grifo termostático empotrado

PVP: 165,00 €

### Cuerpo en caja empotrable

Profundidad: 63 mm





# Serie **KRABI**

## **121615**

### **Conjunto Termostático Empotrado 2 VIAS**

Rociador antical acero SS304 de 250 mm  
Grifo termostático empotrado de 2 vías  
Caja registrable  
Brazo de ducha de 1/2x37 cm  
Salida para flexo c/ soporte integrado  
Flexo reforzado cromado 1,50-2,0 m.  
Ducha de 3 posiciones  
Acabado: Cromo

**PVP: 270,00 €**

## **121614**

### **Grifo Termostático empotrado**

Acabado cromo  
Incluye caja registrable  
No incluye flexo ni mango de ducha

**PVP: 155,00 €**

### **Cuerpo en caja empotrable**

Profundidad: 63 mm



# Serie **KRABI** Negro

PVD

## 121615NG

### Conjunto Termostático Empotrado 2 VIAS

Rociador antical acero SS304 de 250 mm  
 Grifo termostático empotrado de 2 vías  
 Caja registrable  
 Brazo de ducha de 1/2x37 cm  
 Salida para flexo c/ soporte integrado  
 Flexo reforzado cromado 1,70 m. PVC  
 Ducha de 3 posiciones  
 Acabado: Negro

PVP: 330,00 €

## 121614NG

### Grifo Termostático empotrado

Acabado Negro  
 Incluye caja registrable  
 No incluye flexo ni mango de ducha

PVP: 175,00 €

### Cuerpo en caja empotrable

Profundidad: 63 mm



Serie **KRABI** Oro

PVD

**121615OR****Conjunto Termostático Empotrado 2 VIAS**

Rociador antical acero SS304 de 250 mm  
 Grifo termostático empotrado de 2 vías  
 Caja registrable  
 Brazo de ducha de 1/2x37 cm  
 Salida para flexo c/ soporte integrado  
 Flexo 1,7 PVC ORO  
 Ducha de 3 posiciones  
 Acabado: Oro Cepillado

PVP: 330,00 €

**121614NG****Grifo Termostático empotrado**

Acabado Oro Cepillado  
 Incluye caja registrable  
 No incluye flexo ni mango de ducha

PVP: 175,00 €

**Cuerpo en caja empotrable**

Profundidad: 63 mm



# Serie **KRABI** Rosa

PVD

## 121615RC

### Conjunto Termostático Empotrado 2 VIAS

Rociador antical acero SS304 de 250 mm  
 Grifo termostático empotrado de 2 vías  
 Caja registrable  
 Brazo de ducha de 1/2x37 cm  
 Salida para flexo c/ soporte integrado  
 Flexo 1,7 PVC ROSA  
 Ducha de 3 posiciones  
 Acabado: Rosa Cepillado

PVP: 330,00 €

## 121614RC

### Grifo Termostático empotrado

Acabado Rosa Cepillado  
 Incluye caja registrable  
 No incluye flexo ni mango de ducha

PVP: 175,00 €

### Cuerpo en caja empotrable

Profundidad: 63 mm



# Serie **KRABI** Gris metal PVD



## 121615GM

### Conjunto Termostático Empotrado 2 VIAS

Rociador antical acero SS304 de 250 mm  
 Grifo termostático empotrado de 2 vías  
 Caja registrable  
 Brazo de ducha de 1/2x37 cm  
 Salida para flexo c/ soporte integrado  
 Flexo 1,7 PVC GRIS  
 Ducha de 3 posiciones  
 Acabado: Gris metal

PVP: 330,00 €

## 121614GM

### Grifo Termostático empotrado

Acabado Rosa Cepillado  
 Incluye caja registrable  
 No incluye flexo ni mango de ducha

PVP: 175,00 €

### Cuerpo en caja empotrable

Profundidad: 63 mm



# Grifería de COCINA

■ Serie 121112	228 / 229	
■ Serie TAO	230 / 231	
■ Serie OKI	232 / 233	
■ Serie KÍOS	234 / 235	
■ Serie KÍOS Gris metal	236 / 237	
■ Serie YDRA	238 / 239	
■ Serie ELBA	240 / 241	● ○
■ Serie ELBA bicolor	242 / 243	● ○
■ Serie QALA	244 / 245	● ○
■ Serie QALA bicolor	246 / 247	● ○
■ Serie KU	248 / 249	
■ Serie 121113	250 / 251	
■ Serie CORVO	252 / 253	● ○
■ Serie 121117	254 / 255	
■ Serie 121115	256 / 257	
■ Serie 121105	258 / 259	
■ Serie 121805	260 / 261	
■ Serie NEW Osmosis	262 / 263	● ●
■ Serie 121704 Osmosis	264 / 265	
■ Serie 121708 Osmosis	266 / 267	
■ Serie CISNE	268	
■ Serie ALFA	269 / 273	
■ Serie CLASSIC	274 / 277	
■ Serie BASIC	278 / 279	

# Serie 121112



## 121112

**Monomando fregadero flexible**  
/ Sink mixer

Acabado cromo  
Cartucho 35 mm.

PVP: 160,00 €

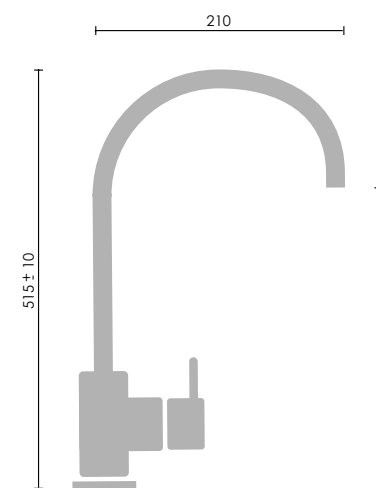

# Serie TAO



**121116**

**Monomando fregadero flexible / Sink mixer**

Acabado cromo  
Cartucho 35 mm.

PVP: 130,00 €

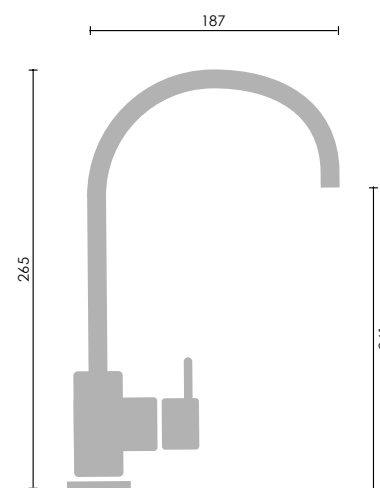

# Serie OKI



**121016**

**Monomando fregadero / Sink mixer**

Acabado cromo  
Cartucho 35 mm.

PVP: 117,00 €

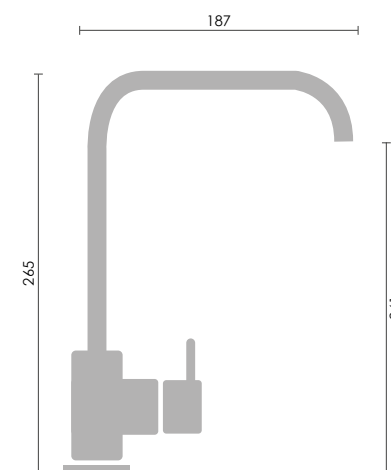

# Serie **KÍOS**



**121035**

**Monomando fregadero / Sink mixer**

Acabado cromo  
Cartucho 35 mm.

PVP: 109,00 €

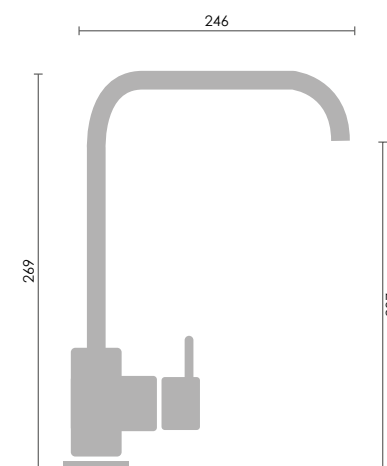

# Serie **BARI** Gris metal

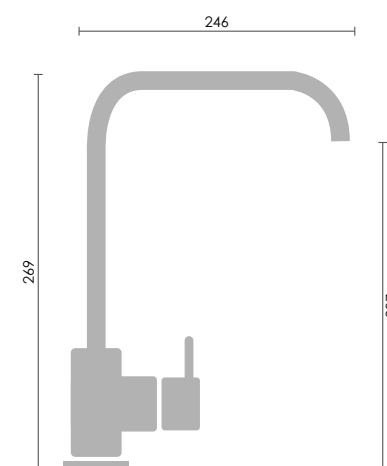

## **121649GM**

**Monomando fregadero / Sink mixer**

Acabado gris metal  
Cartucho 35 mm.

**PVP: 118,00 €**

## **121649**

**Monomando fregadero / Sink mixer**

Acabado cromo  
Cartucho 35 mm.

**PVP: 89,00 €**



# Serie **YDRA**



**121205**

**Monomando fregadero / Sink mixer**

Acabado cromo  
Cartucho 35 mm.  
Apertura en frío

**PVP: 82,00 €**

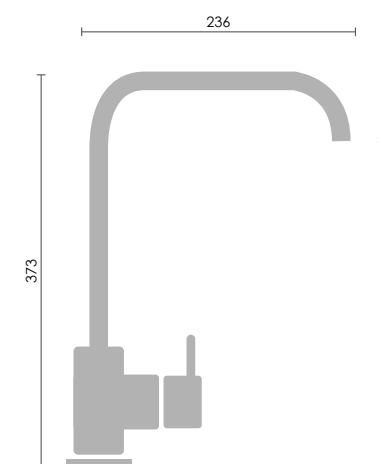

# Serie ELBA



**121019NG**

**Monomando fregadero / Sink mixer**

Acabado negro mate  
Cartucho 35 mm.

PVP: 98,00 €

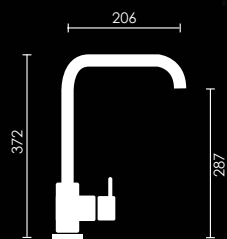

**121019**

**Monomando fregadero / Sink mixer**

Acabado cromo  
Cartucho 35 mm.

PVP: 88,00 €

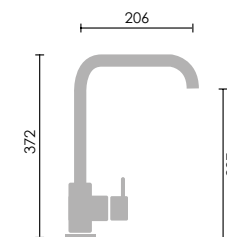

**121019BL**

**Monomando fregadero / Sink mixer**

Acabado blanco  
Cartucho 35 mm.

PVP: 98,00 €

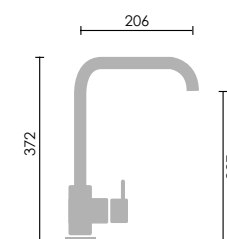

**121019IN**

**Monomando fregadero / Sink mixer**

Acabado cromo inox.  
Cartucho 35 mm.

PVP: 102,00 €

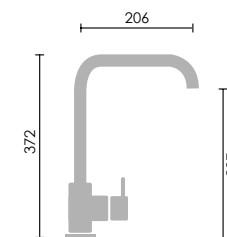

# Serie **ELBA** Bicolor



**121019 CN**

**Monomando fregadero / Sink mixer**

Acabado cromo - negro mate  
Cartucho 35 mm

PVP: 93,00 €

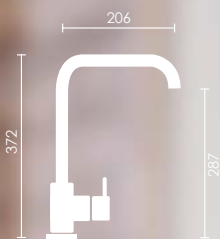

**121019 CB**

**Monomando fregadero / Sink mixer**

Acabado cromo - blanco  
Cartucho 35 mm

PVP: 93,00 €

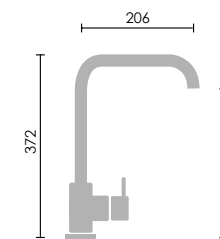

# Serie QALA

**121020IN**

**Monomando fregadero / Sink mixer**

Acabado acero inox.  
Cartucho 35 mm.

PVP: 102,00 €

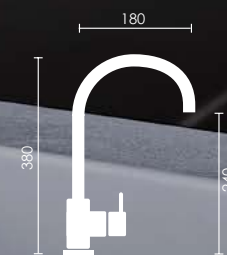

**121020NG**

**Monomando fregadero / Sink mixer**

Acabado cromo negro mate  
Cartucho 35 mm

PVP: 98,00 €

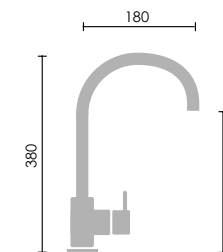

**121020BL**

**Monomando fregadero / Sink mixer**

Acabado blanco  
Cartucho 35 mm

PVP: 98,00 €

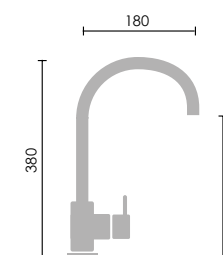

**121020**

**Monomando fregadero / Sink mixer**

Acabado cromo  
Cartucho 35 mm

PVP: 88,00 €

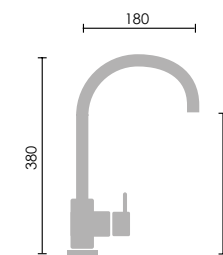

# Serie **QALA** Bicolor



**121020 CB**

**Monomando fregadero / Sink mixer**

Acabado cromo - blanco  
Cartucho 35 mm

PVP: 93,00 €

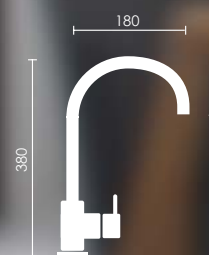

**121020 CN**

**Monomando fregadero / Sink mixer**

Acabado cromo - negro mate  
Cartucho 35 mm

PVP: 93,00 €

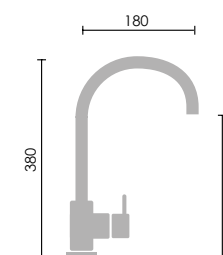

# Serie **KU**



**121005**

**Monomando fregadero / Sink mixer**

Acabado cromo  
Cartucho 35 mm.

PVP: 110,00 €

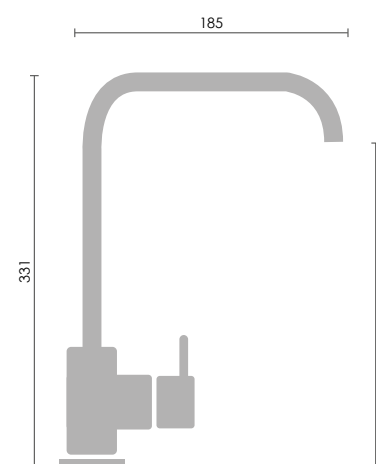

# Serie **121113**



## **121113**

**Monomando fregadero extraible /**  
Sink mixer

Acabado cromo  
Cartucho 35 mm.  
Flexo extraible 1,50 m

**PVP: 115,00 €**

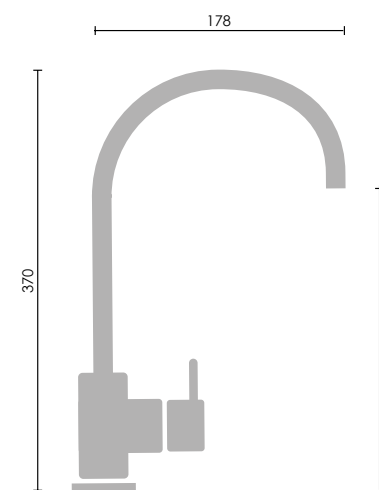

# Serie CORVO



252

clausyath

**121018**

**Monomando fregadero CORVO B / Sink mixer**

Acabado blanco-cromo  
Cartucho 35 mm.

PVP: 67,00 €

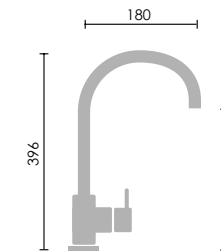

Crifería de  
**COCINA**

**121017**

**Monomando fregadero CORVO N / Sink mixer**

Acabado negro-cromo  
Cartucho 35 mm.

PVP: 67,00 €

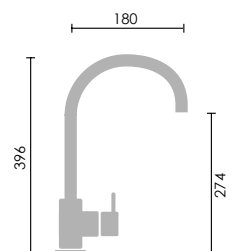

253

# Serie **121117**



## **121117**

**Monomando fregadero tubo / Sink mixer**

Acabado cromo  
Cartucho 35 mm.  
Aireador H22 mm

**PVP: 71,00 €**

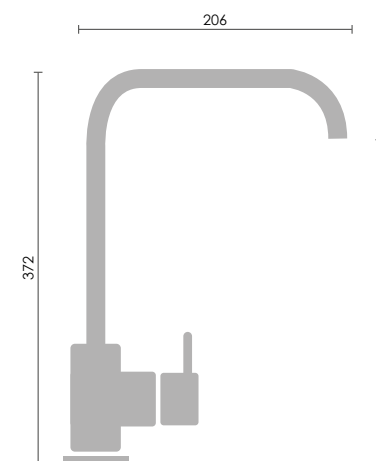

# Serie 121115



## 121115

**Monomando fregadero recto / Sink mixer**

Acabado cromo  
Cartucho 35 mm.  
Aireador H22 mm

**PVP: 79,00 €**

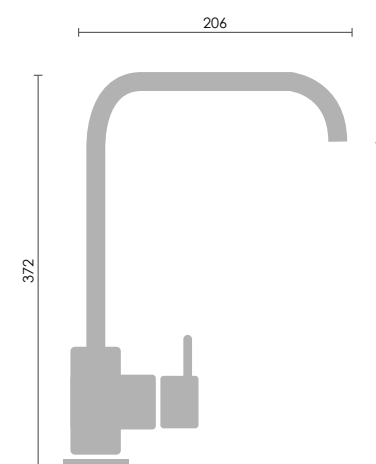

# Serie **121105**



## **121105**

**Monomando fregadero curvo /**

Sink mixer

Acabado cromo  
Cartucho 35 mm  
Aireador H22 mm

**PVP: 72,00 €**

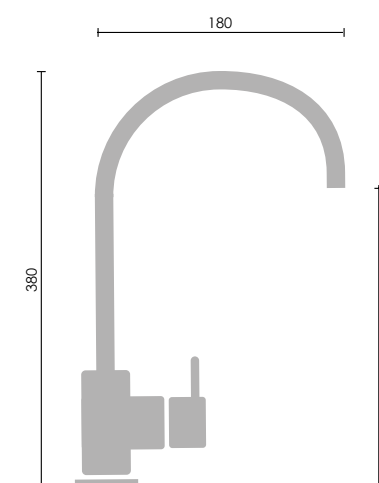

# Serie **121805**



## **121805**

**Monomando fregadero KOBA / Sink mixer**

Acabado cromo  
Cartucho 35 mm  
Aireador H22 mm

**PVP: 57,00 €**

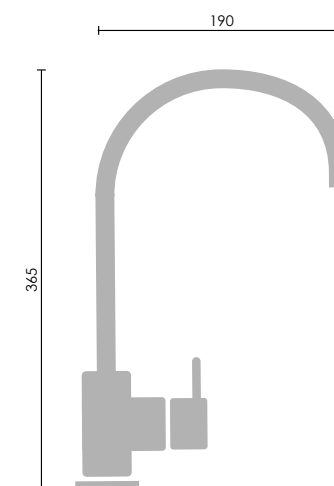

# Serie **NEW** Osmosis

**121709**

**Monomando fregadero new OSMOSIS / Sink mixer**

Acabado cromo  
Cartucho 35 mm.  
Aireador H22 mm

PVP: 146,00 €

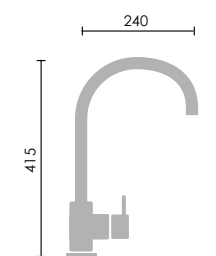

Crifería de **COCINA**

**121709 NG**

**Monomando fregadero new OSMOSIS / Sink mixer**

Acabado negro  
Cartucho 35 mm.  
Aireador H22 mm

PVP: 152,00 €

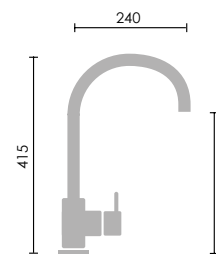

**121709 OR**

**Monomando fregadero new OSMOSIS / Sink mixer**

Acabado oro  
Cartucho 35 mm.  
Aireador H22 mm

PVP: 168,00 €

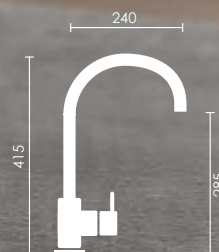

# Serie **121704** Osmosis



## **121704**

**Monomando fregadero OSMOSIS / Sink mixer**

2 posiciones:

- Agua sanitaria
- Filtros (osmosis)

Acabado cromo  
Cartucho 35 mm  
Aireador M24 mm  
Aireador osmosis M18 mm

**PVP: 131,00 €**

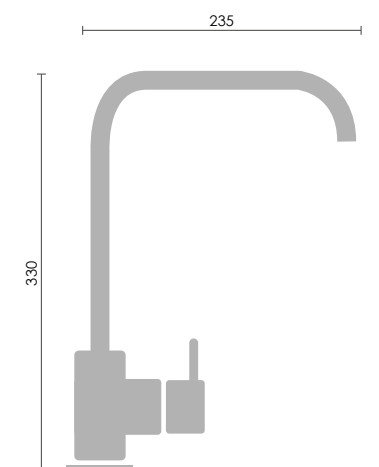

# Serie **121708** Osmosis



## **121708**

**Monomando fregadero OSMOSIS / Sink mixer**

2 posiciones:

- Agua sanitaria
- Filtros (osmosis)

Acabado cromo  
 Cartucho 35 mm  
 Aireador M24 mm  
 Aireador osmosis M18 mm

PVP: 155,00 €

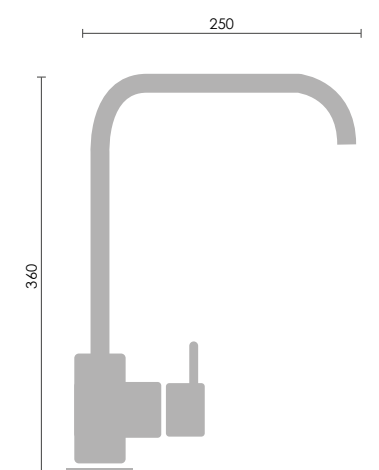

# Serie CISNE

# Serie ALFA

**121123**

**Monomando fregadero CISNE / Sink mixer**

Acabado cromo  
Cartucho 40 mm.  
Aireador H22 mm

**PVP: 44,00 €**

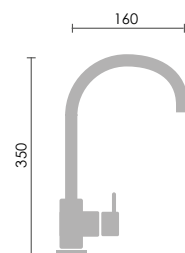

**121305**

**Monomando fregadero caño fundido / Sink mixer**

Acabado cromo  
Cartucho 40 mm.  
Aireador M24 mm

**PVP: 79,00 €**

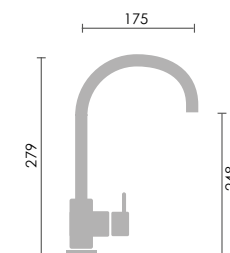

**121306**

**Monomando fregadero caño conformado / Sink mixer**

Acabado cromo  
Cartucho 40 mm.  
Aireador M24 mm

**PVP: 42,00 €**

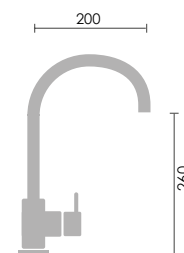

# Serie ALFA



**121316**  
**Monomando fregadero / Sink mixer**  
 Acabado cromo  
 Cartucho 40 mm.  
 PVP: 44,00 €



**121307**  
**Monomando fregadero caño giratorio / sink mixer**

Acabado cromo  
 Cartucho 40 mm.  
 Aireador M24 mm.

PVP: 44,00 €

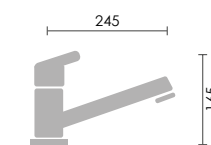

**121310**  
**Monomando fregadero extraíble alto / Removable sink mixer**

Flexo extraíble 1,50 m  
 Ducha ABS 2 posiciones  
 Acabado cromo  
 Cartucho 40 mm.

PVP: 84,00 €

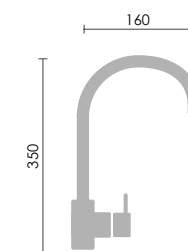

**121311**  
**Monomando fregadero extraíble bajo / Removable sink mixer**

Flexo extraíble 1,50 m  
 Ducha ABS 2 posiciones  
 Acabado cromo  
 Cartucho 40 mm.

PVP: 75,00 €

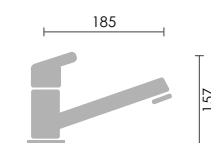

# Serie ALFA



**121314**

**Monomando fregadero pared caño alto (13x17) / Wall sink mixer**

Acabado cromo  
Cartucho 40 mm.

PVP: 65,00 €

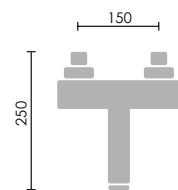

**121315**

**Monomando fregadero pared caño conformado (9x13) / Wall sink mixer**

Acabado cromo  
Cartucho 40 mm.  
Aireador M24 mm.

PVP: 65,00 €

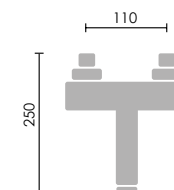

**121308**

**Monomando fregadero pared caño fundido (13x17) / Wall sink mixer**

Acabado cromo  
Cartucho 40 mm.  
Aireador M24 mm.

PVP: 80,00 €

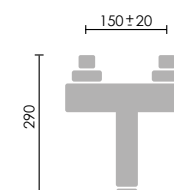

**121309**

**Monomando fregadero pared caño bajo (13x17) / Wall sink mixer**

Acabado cromo  
Cartucho 40 mm.  
Aireador M24 mm.

PVP: 68,00 €

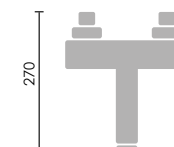

# Serie CLASSIC



**121407**  
**Batería fregadero pared (13x17) / Wall sink mixer**

Acabado cromo  
 Montura cerámica 1/4 v  
 Aireador H22 mm.

PVP: 95,00 €

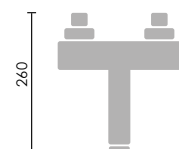

**121408**  
**Grifo fregadero giratorio / Wall mounted tap**

Acabado cromo  
 Montura cerámica 1/4 v  
 Aireador H22 mm.

PVP: 42,00 €



**121405**  
**Monobloc fregadero caño giratorio / Mono sink mixer**

Acabado cromo  
 Montura cerámica 1/4 v  
 Aireador H22 mm.

PVP: 71,00 €

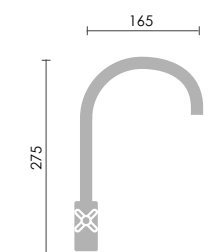

**121406**  
**Monobloc fregadero caño giratorio / Mono sink mixer**

Acabado cromo  
 Montura cerámica 1/4 v  
 Aireador H22 mm.

PVP: 118,00 €

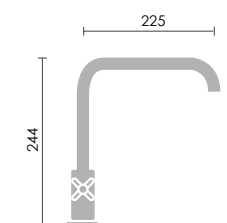

La serie classic se puede servir con montura convencional.

# Serie CLASSIC

**121416**  
**Monobloc fregadero caño giratorio**  
 / Mono sink mixer

Acabado bronce  
 Montura cerámica 1/4 v  
 Aireador H22 mm.

PVP: 135,00 €

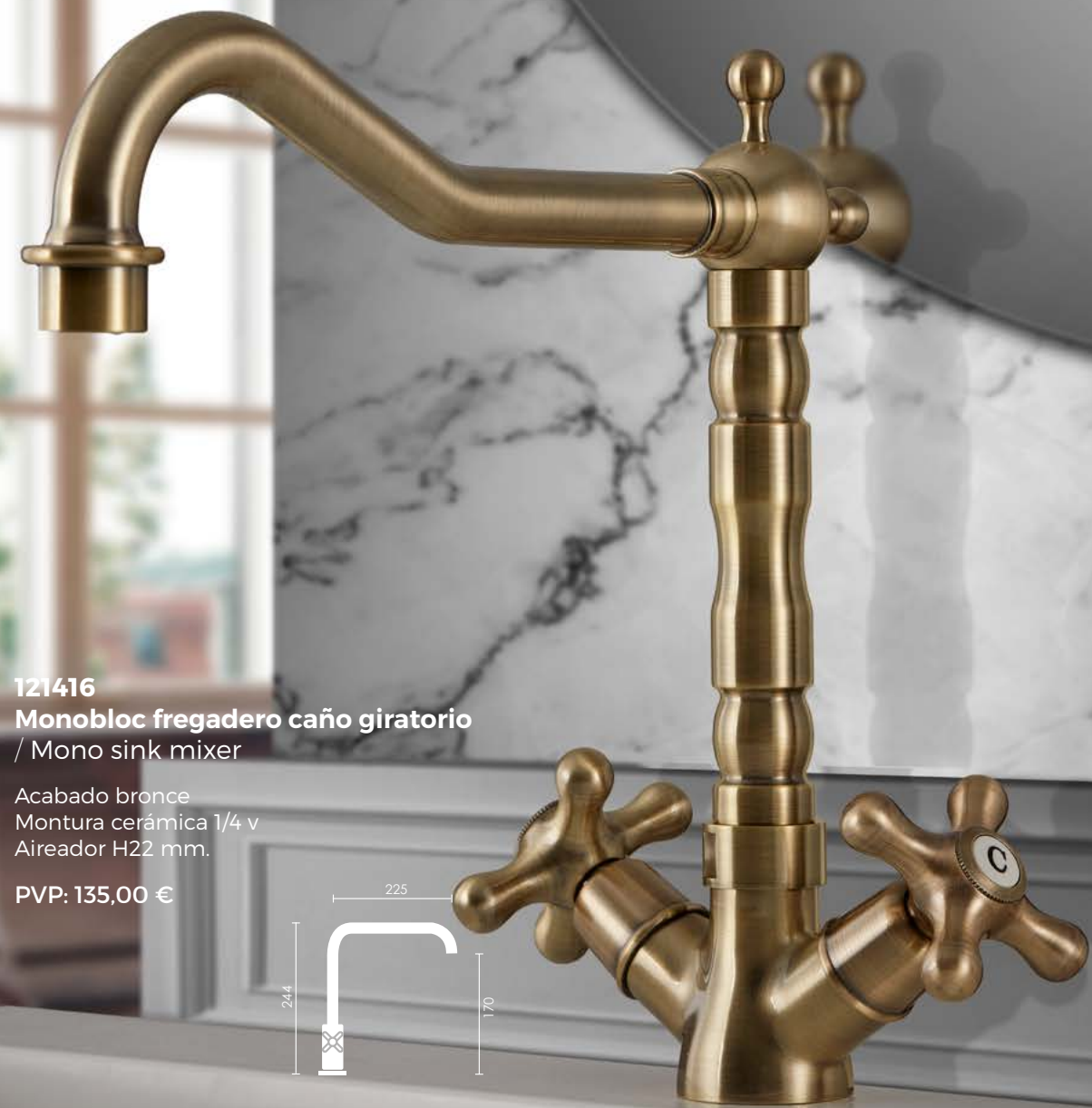
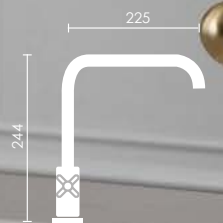

**121415**  
**Monobloc fregadero / Mono sink**  
 mixer

Acabado bronce  
 Montura cerámica 1/4 v  
 Aireador H22 mm.

PVP: 87,00 €

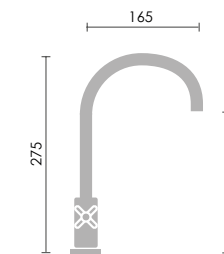

**121417**  
**Batería fregadero pared (13x17) /**  
 Wall sink mixer

Acabado bronce  
 Montura cerámica 1/4 v  
 Aireador H22 mm.

PVP: 115,00 €

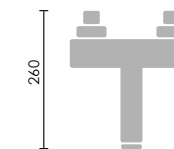

La serie classic se puede servir con montura convencional.

# Serie **BASIC**

**121507**

**Grifo fregadero 1/2 fijo (14 cm. 1/2) /**  
Wall mounted tap

Acabado cromo  
Montura cerámica 1/4 v

PVP: 21,00 €

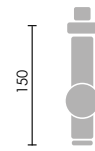

**121510**

**Grifo lavavajillas /** Mixer for washing machine

Acabado cromo  
Montura cerámica 1/4 v

PVP: 22,00 €

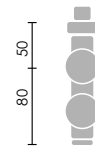

**121509**

**Grifo lavavajillas doble /** Mixer for washing machine

Acabado cromo  
Montura cerámica 1/4 v

PVP: 22,00 €

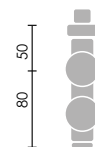

**Batería fregadero pared /** Wall mounted kitchen mixer

Acabado cromo  
Montura cerámica 1/4 v

**121504 (13x17)**

PVP: 54,00 €

**121505 (9x13)**

PVP: 53,00 €

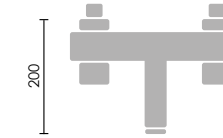

**121506**

**Grifo fregadero giratorio /** Wall mounted tap

Acabado cromo  
Montura cerámica 1/4 v

PVP: 23,70 €



**121508**

**Grifo lavadora normal /** Mixer for washing machine

Acabado cromo  
Montura cerámica 1/4 v

PVP: 10,40 €



# Grifería **ESPECIAL**

■ Serie SWAN	282 / 283
■ Serie WEI	284 / 285
■ BIDÉ Inodoro	286 / 292
■ Monomando 1 agua	293
■ Grifería termostática	294 / 295
■ Grifería medical	296 / 297
■ Grifería temporizada	298 / 299



# Serie **SWAN**



**121226**

**Grifería de pie para bañera /  
Sink mixer**

Monomando  
Flexo cromado 1,7 m  
Ducha Minimalista 1 posición  
Acabado cromo  
Cartucho 35 mm

**PVP: 395,00 €**

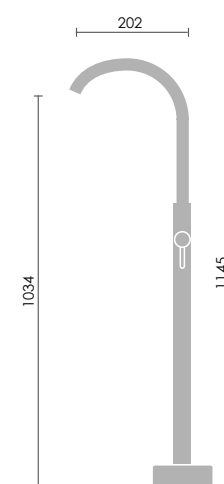

# Serie WEI



**121336**

**Grifería de pie para bañera /**  
Sink mixer

Monomando  
Flexo cromado 1,7 m  
Ducha Minimalista 1 posición  
Acabado cromo  
Cartucho 35 mm

**PVP: 470,00 €**

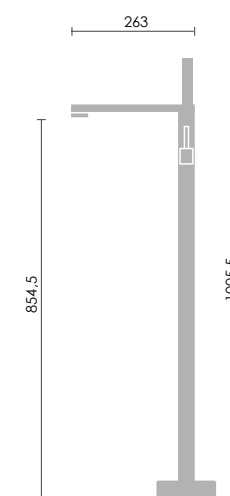

# Serie **BIDÉ** Inodoro

Conjunto sustitución  
de bidé

**121108**

**Conjunto sustitución bidé 2 aguas /**  
Supply bidet

Flexo cromado 1,20 antitorsión  
Acabado cromo  
Cartucho 35 mm.

PVP: 95,00 €

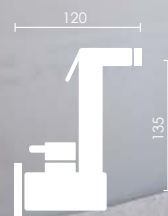

# Serie **BIDÉ** Inodoro negro



**121108 NG**

**Conjunto sustitución bidé 2 aguas /**  
Supply bidet

Flexo 1,20 PVC negro  
Acabado negro mate  
Cartucho 35 mm.

PVP: 118,00 €

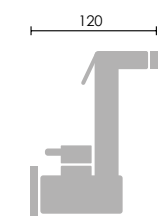



**121108OR**

**Conjunto sustitución bidé 2 aguas /  
Supply bidet**

Flexo cromado 1,20 oro cepillado  
Acabado oro cepillado  
Cartucho 35 mm.

PVP: 135,00 €

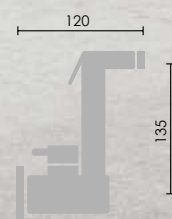

**121108GM**

**Conjunto sustitución bidé 2 aguas /  
Supply bidet**

Flexo 1,20 PVC  
Acabado gris metal  
Cartucho 35 mm.

PVP: 135,00 €

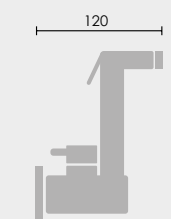

# Serie **BIDÉ** Inodoro negro cuadrado



## 121011 NG

**Conjunto sustitución bidé 2 aguas / Supply bidet**

Flexo 1,20 PVC negro  
Acabado negro mate  
Cartucho 35 mm.

PVP: 141,00 €

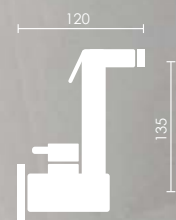

# Serie **BIDÉ** Inodoro cuadrado



## 121011

**Conjunto sustitución bidé 2 aguas / Supply bidet**

Flexo cromado 1,20 antitorsión  
Acabado cromo  
Cartucho 35 mm.

PVP: 115,00 €

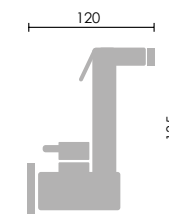

# Serie **BIDÉ** Inodoro



Soporte incorporado en el cuerpo de la grifería

**121124**

**Conjunto bidé inodoro 1 agua /**  
Supply bidet

Acabado cromo  
Montura cerámica 1/4 v

PVP: 57,00 €

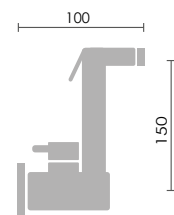

## Monomando de 1 agua

**121503M**

**Monomando fregadero vertical /**  
Basin mixer

1 agua  
Acabado cromo  
Cartucho 25 mm.

PVP: 25,80 €

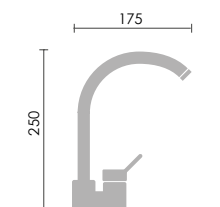

**121501M**

**Monomando lavabo /** Basin mixer

1 agua  
Acabado cromo  
Cartucho 25 mm.

PVP: 23,80 €

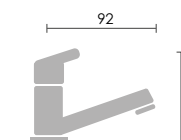

**121507M**

**Monomando fregadero pared /**  
Basin mixer

13 cm. 1 agua  
Acabado cromo  
Cartucho 25 mm.

PVP: 22,80 €

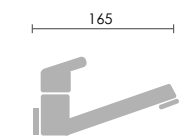

# Grifería termostática

**Bol**  
**121601**

**Termostático de baño para ducha /**  
Thermostatic bath shower mixer

Flexo, mango de ducha y soporte  
Acabado cromo

PVP: 135,00 €



**Cube**  
**121604**

**Termostático de baño para ducha /**  
Thermostatic bath shower mixer

Flexo, mango de ducha y soporte  
Acabado cromo

PVP: 165,00 €



**Bol**  
**121602**

**Termostático para ducha /**  
Thermostatic shower mixer

Flexo, mango de ducha y soporte  
Acabado cromo

PVP: 108,00 €



**Cube**  
**121605**

**Termostático para ducha /**  
Thermostatic shower mixer

Flexo, mango de ducha y soporte  
Acabado cromo

PVP: 140,00 €



**Bol**  
**121603**

**Termostático para ducha /**  
Thermostatic shower mixer

Salida superior 3/4  
Acabado cromo

PVP: 115,00 €



**Cube**  
**121606**

**Termostático para ducha /**  
Thermostatic shower mixer

Salida superior 3/4  
Acabado cromo

PVP: 145,00 €



## Grifería medical

**121701**

**Monomando lavabo**  
**Palanca gerontológica / Basin mixer**

Acabado cromo  
Cartucho 40 mm

PVP: 52,00 €

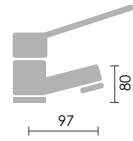

**121702**

**Monomando fregadero**  
**Palanca gerontológica**  
**Caño giratorio bajo /**

Sink mixer with tilted rotating spout

Acabado cromo  
Cartucho 40 mm

PVP: 67,00 €

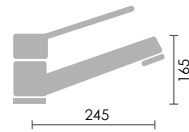

**121703**

**Monomando fregadero mural**  
**Palanca gerontológica / Sink mixer**

Acabado cromo  
Cartucho 40 mm

PVP: 85,00 €

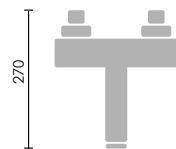

## Grifería medical de 1 agua

**121707**

**Grifería pared medical 1/2 /**  
Wall tap

Caño giratorio 1 agua  
Cromo  
Montura cerámica 1/4 v

PVP: 78,00 €



**121706**

**Grifería pared medical 1/2 /**  
Wall tap

Caño fijo 1 agua  
Cromo  
Montura cerámica 1/4 v

PVP: 60,00 €



# Grifería temporizada

**121711**

**Grifo lavabo 1/2 / Sink faucet**

Acabado cromo

PVP: 40,00 €

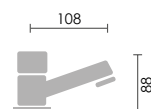

**121715**

**Ducha temporizada empotrada / Built-in timer shower mixer**

Acabado cromo

PVP: 56,00 €

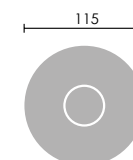

**121712**

**Grifo lavabo 1/2 / Sink faucet**

Acabado cromo

PVP: 58,00 €

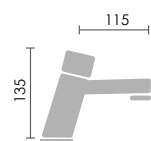

**121714**

**Grifo de urinario 1/2 / Urinary tap 1/2**

Acabado cromo

PVP: 36,00 €

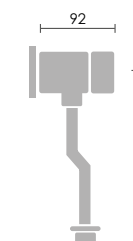

**121713**

**Grifo frontal 1/2 / Sink faucet**

Acabado cromo

PVP: 38,00 €

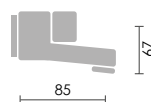

# COMPLEMENTOS

■ JABONERAS	302 / 309	● ● ● ○
■ ASIENTOS	310 / 311	
■ ASIDEROS	312 / 313	● ● ● ○
■ PORTARROLLO	314 / 315	● ● ● ○
■ TOALLEROS	316 / 139	● ● ● ○
■ PERCHA	320 / 321	● ● ● ○
■ ROCIADORES	322 / 325	● ● ● ○
■ BRAZOS DE DUCHA	326 / 328	● ● ● ○
■ CODOS DE DUCHA	329 / 330	● ● ● ○
■ SIFONES	331 / 333	● ● ● ○
■ BRAZOS DESLIZANTES	334 / 335	
■ MANGOS DE DUCHA	336 / 340	● ● ○
■ SOPORTES	341	
■ FLEXOS	342 / 343	● ● ○
■ VÁLVULAS CLIC-CLAC	344 / 345	● ● ● ○

# JABONERAS

**123706**

## Jabonera para barra de ducha

Para diámetro de barra desde 22 a 25 cm  
Acero inox.  
Cromo brillo

PVP: 40,00 €

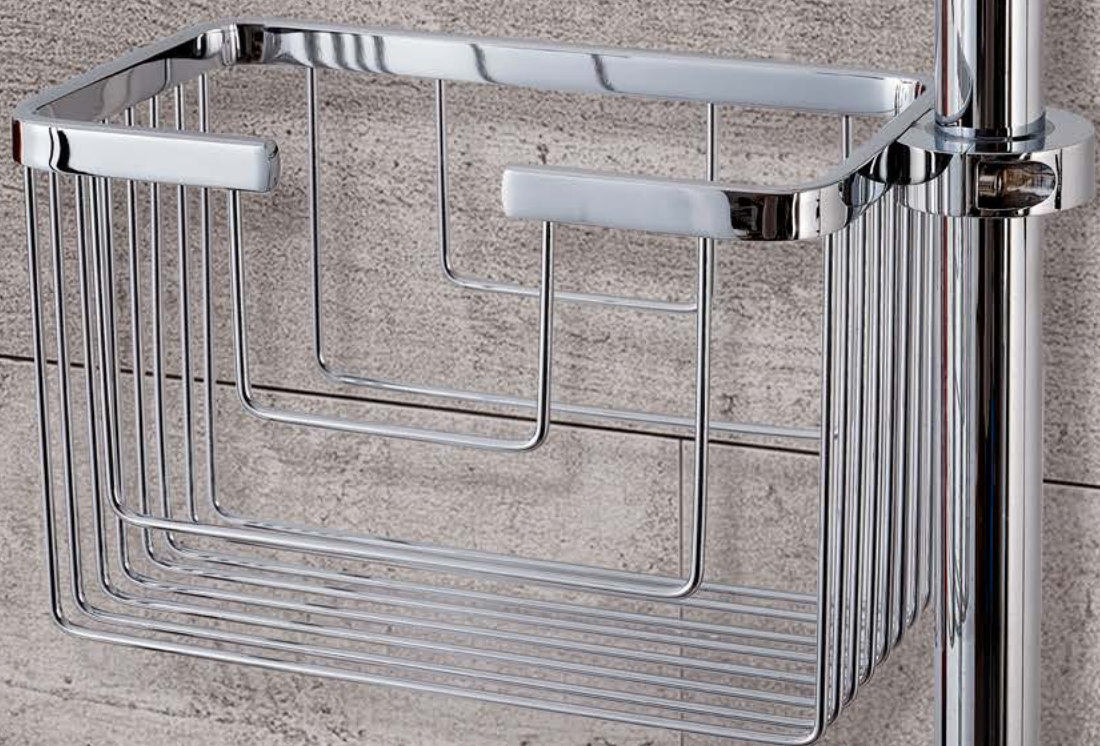
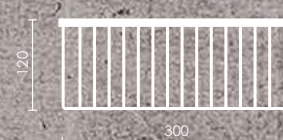
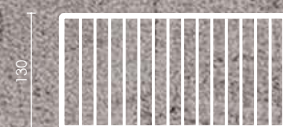

**123702**

## Jabonera de rincón

Altura 14 cm  
Acero inox.  
Cromo brillo

PVP: 32,00 €

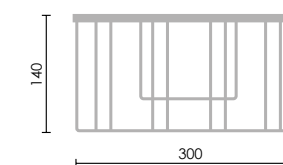
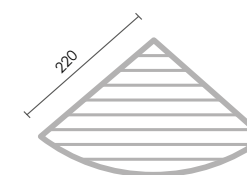

**123703**

## Jabonera de rincón

Altura 8 cm  
Acero inox.  
Cromo brillo

PVP: 29,00 €

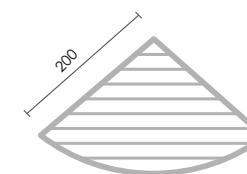

# JABONERAS

**123701**

**Jabonera para grifería**

Acero inox.  
Cromo brillo

PVP: 43,00 €

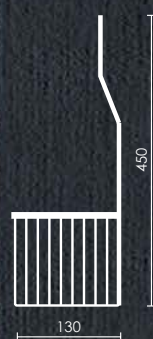
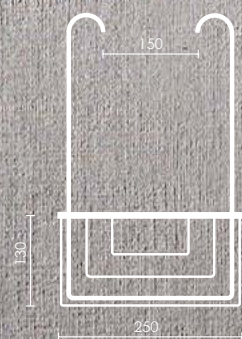

**123708**

**Jabonera para grifería**

Acero inox.  
Cromo brillo

PVP: 38,00 €

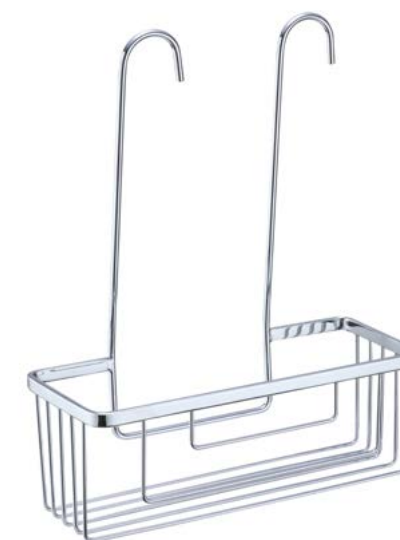
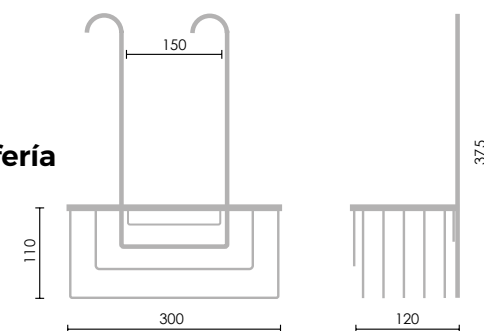

**123708 NG**

**Jabonera para grifería**

Acero inox.  
Negro mate

PVP: 43,00 €

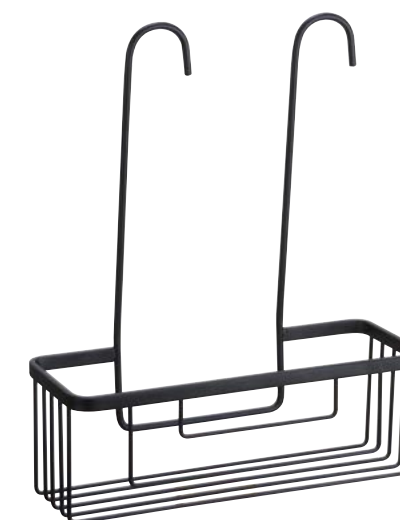
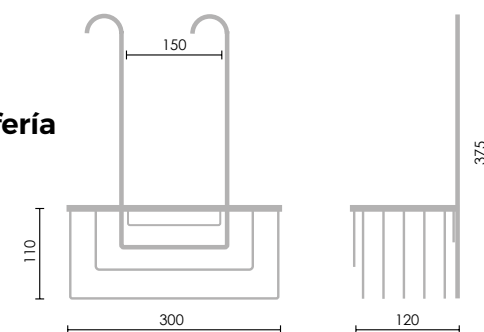

# JABONERAS

**123708 BL**

**Jabonera para grifería**

Acero inox.  
Blanco mate

**PVP: 43,00 €**

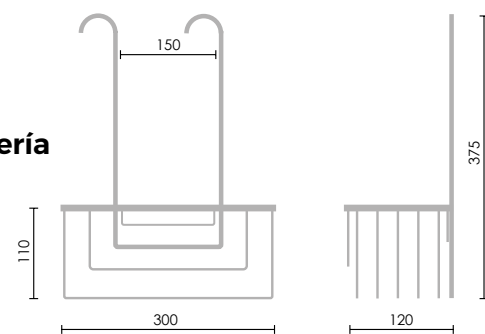

**123708OC**

**Jabonera para grifería**

Acero inox. SS304  
Oro cepillado

**PVP: 46,00 €**

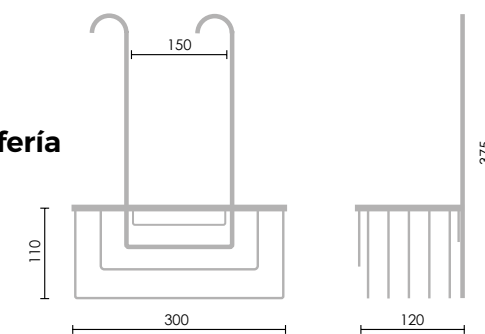

**123708RC**

**Jabonera para grifería**

Acero inox. SS304  
Rosa cepillado

**PVP: 46,00 €**

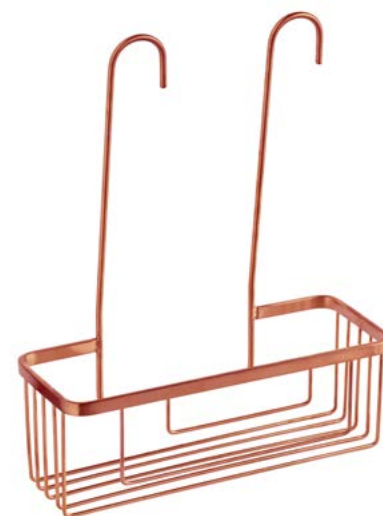
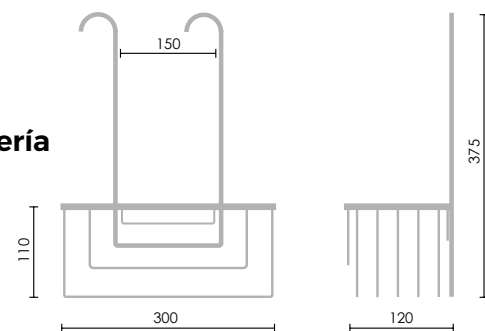

**123708GM**

**Jabonera para grifería**

Acero inox. SS304  
Gris metal

**PVP: 46,00 €**

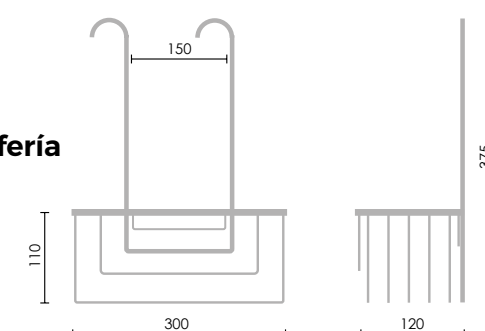

# JABONERAS

**123705**

**Jabonera doble**

Acero inox.  
Cromo brillo

PVP: 68,00 €

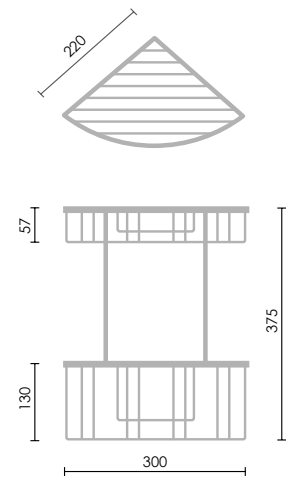

**123704**

**Jabonera rectangular**

Altura 12 cm  
Acero inox.  
Cromo brillo

PVP: 32,00 €

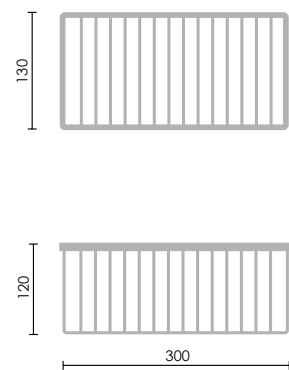

**123707**

**Jabonera recta de rincón**

Altura 16 mm  
Latón  
Cromo brillo

PVP: 45,00 €

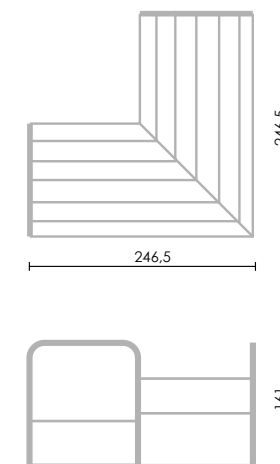

# ASIENTOS



**123415**

## Banqueta con patas

Soporta 110 kg  
Patas regulables en altura de 45 a 57 cm

PVP: 46,00 €

**123412**

## Asiento plegable

Peso máximo 150 kg  
Madera de Teka  
Aluminio anodizado

PVP: 88,00 €



**123410**

## Asiento plegable

Soporta 200 kg de forma segura  
Patas de acero con recubrimientos Epoxi  
Plataforma de sujeción a la pared de aluminio  
Asiento ABS

PVP: 94,00 €

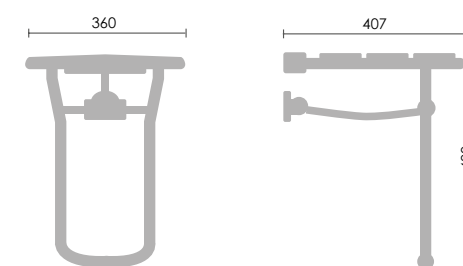

# ASIDEROS

## Asidero de baño reforzado

**123405** 25 cm PVP: 22,00 €

**123406** 30 cm PVP: 23,00 €

**123407** 40 cm PVP: 26,00 €



## Asidero de baño reforzado

Negro mate

**123406NG** 30 cm PVP: 26,00 €



## Asidero de baño reforzado

Oro cepillado

**123406OR** 30 cm PVP: 29,00 €



## Asidero de baño reforzado

Rosa cepillado

**123406RC** 30 cm PVP: 29,00 €



## Asidero de baño reforzado

Gris metal

**123406GM** 30 cm PVP: 29,00 €



## Asidero de baño antideslizante

**123416** 30 cm PVP: 25,00 €

**123417** 40 cm PVP: 28,00 €



## Asidero de baño antideslizante

Negro mate

**123416NG** 30 cm PVP: 34,00 €



## Asidero de baño antideslizante

Oro cepillado

**123416OR** 30 cm PVP: 34,00 €



## Asidero de baño antideslizante

Rosa cepillado

**123416RC** 30 cm PVP: 34,00 €

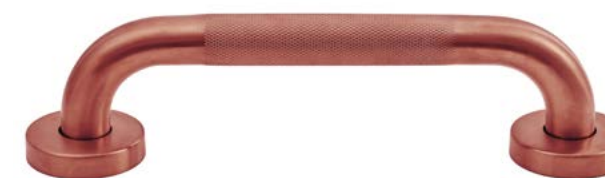

## Asidero de baño antideslizante

Gris metal

**123416GM** 30 cm PVP: 34,00 €



# PORTARROLLO

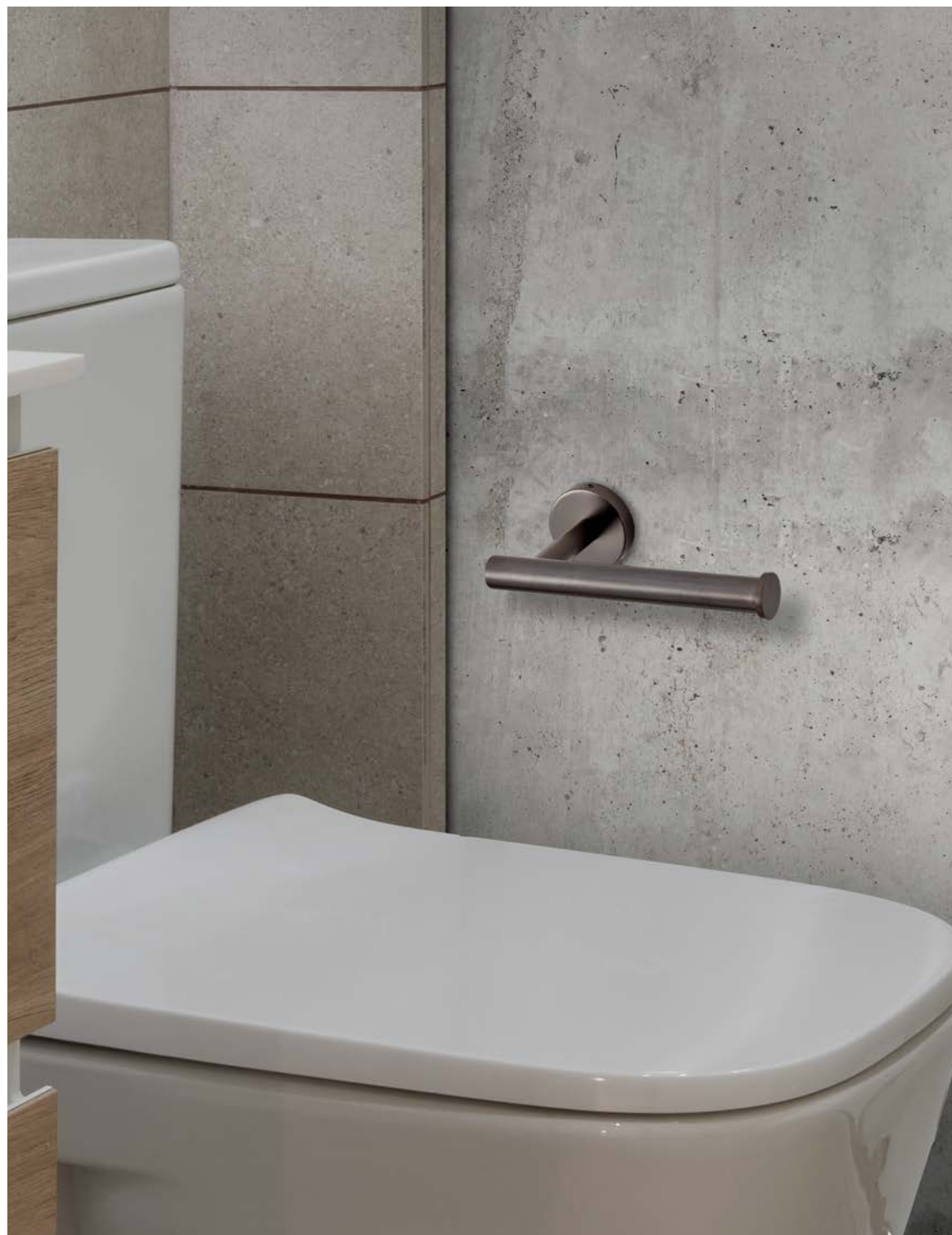

**123423GM**

**Portarrollos** / Toilet paper holder

Acabado gris metal  
Acero SS304

PVP: 22,00 €



**123423**

**Portarrollos** / Toilet paper holder

Acabado CROMO  
Acero SS304

PVP: 17,00 €



**123423NG**

**Portarrollos** / Toilet paper holder

Acabado NEGRO MATE  
Acero SS304

PVP: 19,00 €



**123423OR**

**Portarrollos** / Toilet paper holder

Acabado ORO CEPILLADO  
Acero SS304

PVP: 21,00 €



**123423RC**

**Portarrollos** / Toilet paper holder

Acabado ROSA CEPILLADO  
Acero SS304

PVP: 21,00 €

# TOALLEROS



**123424OR**

**Toallero de barra / Towell bar**

Acabado ORO CEPILLADO  
Acero SS304

PVP: 28,00 €



**123423**

**Toallero de barra / Towell bar**

Acabado CROMO  
Acero SS304

PVP: 24,00 €



**123423NG**

**Toallero de barra / Towell bar**

Acabado NEGRO MATE  
Acero SS304

PVP: 26,00



**123423RC**

**Toallero de barra / Towell bar**

Acabado ROSA CEPILLADO  
Acero SS304

PVP: 28,00



**123423GM**

**Toallero de barra / Towell bar**

Acabado GRIS METAL  
Acero SS304

PVP: 29,00

# PERCHA



**123425RC**

**Percha / Hanger**

Acabado ROSA CEPILLADO  
Acero SS304

PVP: 15,00 €



**123425**

**Percha / Hanger**

Acabado CROMO  
Acero SS304

PVP: 12,00 €



**123425NG**

**Percha / Hanger**

Acabado NEGRO MATE  
Acero SS304

PVP: 14,00 €



**123425OR**

**Percha / Hanger**

Acabado ORO CEPILLADO  
Acero SS304

PVP: 15,00 €



**123425GM**

**Percha / Hanger**

Acabado GRIS METAL  
Acero SS304

PVP: 16,00 €

# TOALLEROS

## Toallero para mueble

Acero inox. 304  
Cromo brillo

**123419** 29 cm Cromo PVP: 24,00 €

**123419NG** 29 cm Negro PVP: 27,00 €



## Toallero para mueble

**123420** 36 cm Cromo PVP: 26,00 €

**123420NG** 36 cm Negro mate PVP: 29,00 €

**123420BL** 36 cm Blanco mate PVP: 29,00 €

**123420OR** 36 cm Oro PVP: 31,00 €

**123420RC** 36 cm Rosa PVP: 31,00 €

**123420GM** 36 cm Gris PVP: 31,00 €



## Toallero para mueble SLIM

Acero inox. 304  
Cromo brillo

**123422** 36 cm. PVP: 18,00 €



# PORTARROLLO

## 123418

### Portarrollos para mueble

Acero inox. 304  
Cromo brillo

PVP: 21,00 €



## 123418NG

### Portarrollos para mueble

Acero inox. 304  
Negro

PVP: 26,00 €



# ROCIADORES

## Rociador redondo 200 RAC

Acero. Anticalcáreo. Con rótula

**123222**     $\phi$  200 mm    PVP: 28,00 €

**123223**     $\phi$  250 mm    PVP: 42,00 €

**123224**     $\phi$  300 mm    PVP: 60,00 €

**123225**     $\phi$  400 mm    PVP: 94,00 €



## Rociador redondo rosa

Acero. Anticalcáreo. Con rótula

**123223RC**     $\phi$  250 mm    PVP: 65,00 €

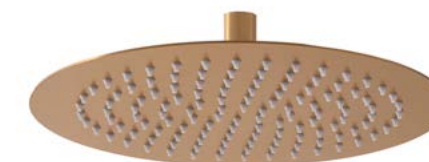

## Rociador redondo negro mate

Acero. Anticalcáreo. Con rótula

**123222NG**     $\phi$  200 mm    PVP: 33,00 €

**123223NG**     $\phi$  250 mm    PVP: 53,00 €

**123224NG**     $\phi$  300 mm    PVP: 72,00 €



## Rociador redondo gris

Acero. Anticalcáreo. Con rótula

**123223GM**     $\phi$  250 mm    PVP: 65,00 €



## Rociador redondo blanco mate

Acero. Anticalcáreo. Con rótula

**123223BL**     $\phi$  250 mm    PVP: 51,00 €



## Rociador cuadrado

Acero. Anticalcáreo. Con rótula

**123226**     $\phi$  200 mm    PVP: 30,00 €

**123227**     $\phi$  250 mm    PVP: 44,00 €

**123228**     $\phi$  300 mm    PVP: 62,00 €

**123229**     $\phi$  400 mm    PVP: 96,00 €



## Rociador redondo oro

Acero. Anticalcáreo. Con rótula

**123223OR**     $\phi$  250 mm    PVP: 65,00 €



# ROCIADORES

## Rociador rectangular

Acero. Anticalcáreo. Con rótula

**123233** 200x250 mm PVP: 44,00 €



## Rociador rectangular

Acero. Anticalcáreo. Con rótula. Negro mate

**123233NG** 200x250 mm PVP: 53,00 €



## Rociador cuadrado negro

Acero. Anticalcáreo. Con rótula

**123226NG** ø 200 mm PVP: 37,00 €

**123227NG** ø 250 mm PVP: 55,00 €

**123228NG** ø 300 mm PVP: 74,00 €

**123229NG** ø 400 mm PVP: 103,00 €



## Rociador redondo 200

ABS. Anticalcáreo. Con rótula

**123204** ø 200 mm PVP: 24,00 €



## Rociador cuadrado 200

ABS. Anticalcáreo. Con rótula

**123203** 200x200 mm PVP: 24,00 €



## Rociador redondo

ABS. Anticalcáreo. Con rótula.

**123232** ø 220 mm PVP: 19,00 €



## Rociador redondo

ABS. Anticalcáreo. Con rótula.

**123201** ø 200 mm PVP: 9,00 €



# BRAZOS DE DUCHA

## 123208

Braço de ducha de 1/2

PVP: 36,00 €

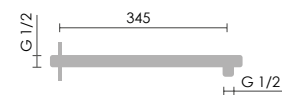

## 123208NG

Braço de ducha de 1/2

PVP: 41,00 €

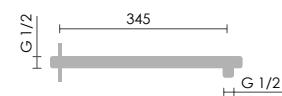

## 123230

Braço de ducha de 1/2

PVP: 35,00 €

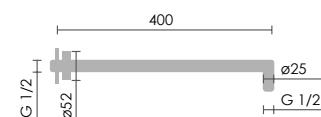

## 123219

Braço de ducha fundido de 1/2x15 16cm

PVP: 10,00 €

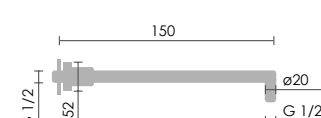

## 123221

Braço de ducha de 1/2x30

PVP: 18,00 €

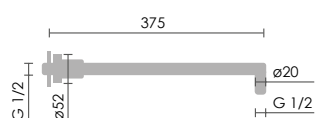

## 123207

Braço de ducha de 1/2

PVP: 28,00 €

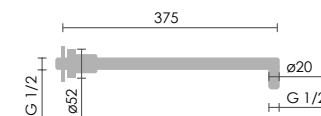

## 123207NG

Braço de ducha de 1/2

PVP: 35,00 €



## 123207OR

Braço de ducha de 1/2

PVP: 36,00 €

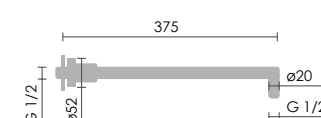

## 123207GM

Braço de ducha de 1/2

PVP: 38,00 €

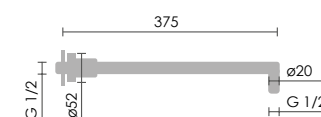

## 123207RC

Braço de ducha de 1/2

PVP: 36,00 €

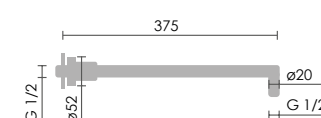

# BRAZOS DE DUCHA

## 123209

Brazo de ducha techo  
PVP: 18,00 €



## 123209RC

Brazo de ducha techo  
PVP: 23,00 €



## 123209NG

Brazo de ducha techo  
PVP: 22,00 €



## 123209OR

Brazo de ducha techo  
PVP: 23,00 €



## 123209GM

Brazo de ducha techo  
PVP: 23,00 €



## 123210

Brazo de ducha techo 17cm  
PVP: 24,00 €



## 123210NG

Brazo de ducha techo 17cm  
PVP: 30,00 €

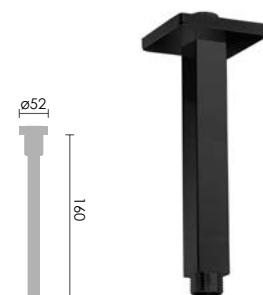

# CODOS DE DUCHA

## 123211

Codo de ducha 1/2 redondo  
PVP: 15,00 €

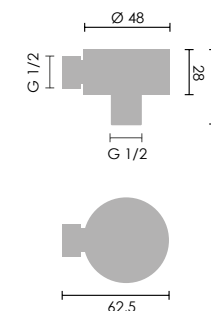

## 123212

Codo de ducha 1/2 cuadrado  
PVP: 17,00 €

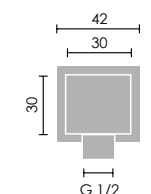

## 123213

Codo de ducha 1/2 con soporte, redondo  
PVP: 27,00 €

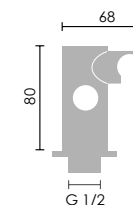

## 123214

Codo de ducha 1/2 con soporte, cuadrado  
PVP: 30,00 €

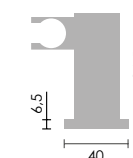

# CODOS DE DUCHA



**123213OR**

Codo de ducha 1/2 con soporte, redondo  
PVP: 36,00 €

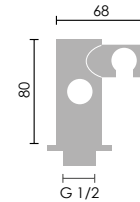

**123213RC**

Codo de ducha 1/2 con soporte, redondo  
PVP: 36,00 €

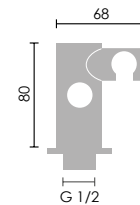

**123213NG**

Codo de ducha 1/2 con soporte, redondo  
PVP: 36,00 €

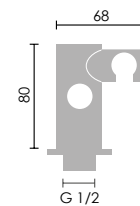

**123214NG**

Codo de ducha 1/2 con soporte, cuadrado  
PVP: 40,00 €

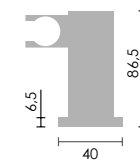

# SIFONES

**123501**

**Sifón telescópico de lavabo cuadrado**

1 1/4 latón  
Cromo

PVP: 44,00 €

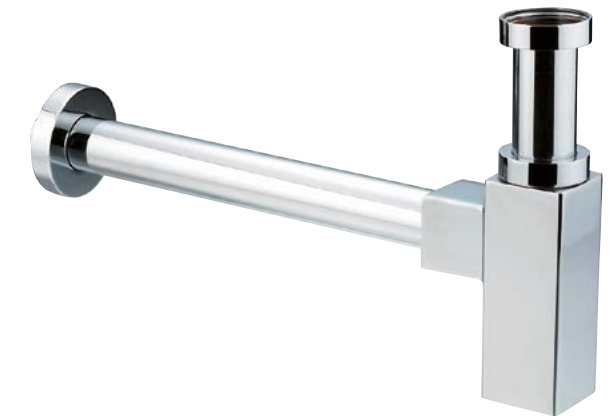

**123502**

**Sifón telescópico de lavabo minimalista**

1 1/4 latón  
Cromo

PVP: 29,00 €



**123503**

**Sifón Botella**

1 1/4 latón  
Cromo

PVP: 16,00 €



**123512**

**Tubo Sifón c/pestaña**

45 cm.  
Cromo

PVP: 15,00 €

**123511**

**Sifón telescópico negro mate**

1 1/4 latón  
Zamak

PVP: 34,00 €



**123511**

**Sifón telescópico gris metal**

1 1/4 latón

PVP: 44,00 €



**123514**

**Sifón telescópico inox.**

1 1/4 latón  
Zamak

PVP: 38,00 €



**123514**

**Sifón telescópico rosa**

1 1/4 latón

PVP: 44,00 €



**123515**

**Sifón telescópico oro cepillado**

1 1/4 latón  
Zamak

PVP: 42,00 €



**Tubo Sifón c/pestaña**

45 cm.

- 123512** PVP: 17,00 €
- 123512OR** PVP: 20,00 €
- 123512RC** PVP: 20,00 €
- 123512GM** PVP: 20,00 €
- 123512NG** PVP: 20,00 €

# BARRAS DESLIZANTES



**122008**

## Conjunto 510

Ducha 5 posiciones  
Barra  $\phi$ 25 mm  
Longitud 70 cm  
Flexo acero inoxidable 1,70 m  
Doble grapado  
Permite aprovechar los agujeros existentes en la pared

**PVP: 31,00 €**



**122030**

## Conjunto 310

Ducha 1 posición  
Barra  $\phi$ 22 mm  
Longitud 60 cm  
Flexo acero inoxidable 1,70 m  
Doble grapado

**PVP: 30,00 €**



**122009**

## Barra deslizante Vip

Barra  $\phi$ 25 mm  
Longitud 70 cm  
Permite aprovechar los agujeros existentes en la pared

**PVP: 18,50 €**



**122040**

## Barra deslizante

Barra  $\phi$ 20 mm  
Longitud 70 cm  
Fabricada íntegramente en latón  
Permite aprovechar los agujeros existentes en la pared

**PVP: 70,00 €**

# MANGOS DE DUCHA

## 123015

### Ducha 500

5 posiciones  
Anticalcárea  
Cromo  
ø 111 mm

PVP: 9,50 €



## 123026

### Ducha 150

1 posición  
Anticalcárea  
ø 74,5 mm

PVP: 7,40 €



## 123009

### Ducha 300

3 posiciones  
Anticalcárea  
Cromo  
ø 95 mm

PVP: 7,90 €



## 123025

### Ducha 140

1 posición  
Anticalcárea  
Cromo  
53 mm

PVP: 7,00 €



## 123001

### Ducha 100

1 posición  
Anticalcárea  
Cromo  
ø 96,5 mm

PVP: 6,80 €



## 123006

### Ducha minimalista

1 posición  
Anticalcárea  
Cromo

PVP: 6,50 €

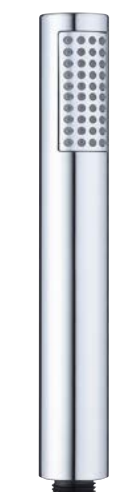

# MANGOS DE DUCHA

**123007**

**Ducha extraíble**

2 posiciones  
Anticalcárea  
Cromo  
ø 57 mm

PVP: 8,80 €



**123014**

**Ducha 400**

4 posiciones  
Autolimpiable  
Cromo  
ø 86 mm

PVP: 8,70 €



**123002**

**Ducha 110**

1 posición  
Anticalcárea  
Cromo  
ø 77,6 mm

PVP: 4,90 €



**123017**

**Ducha 310**

3 posiciones  
Cromo-Blanco  
ø 150 mm

PVP: 9,20 €



**123005**

**Ducha 111**

1 posición  
Anticalcárea  
Cromo  
ø 68,7 mm

PVP: 4,00 €



**123019**

**Ducha 340**

5 posiciones  
Anticalcárea  
Blanco

PVP: 13,00 €



# MANGOS DE DUCHA

**123013**

**Ducha 120**

1 posición  
Negro mate

PVP: 10,40 €



**123010**

**Ducha 320**

5 posiciones  
Negro mate  
ø 100 mm

PVP: 13,00 €



**123020RC**

**Ducha 360**

5 posiciones  
Negro mate  
ø 100 mm

PVP: 16,00 €



**123018**

**Ducha 330**

5 posiciones  
Oro  
ø 100 mm

PVP: 16,00 €



**123022GM**

**Ducha 350**

5 posiciones  
Oro  
ø 100 mm

PVP: 17,00 €



# SOPORTES

**123101**

**Soporte giratorio cónico**

Acabado cromo

PVP: 2,70 €



**123102**

**Soporte cónico minimalista**

Acabado cromo

PVP: 3,50 €



**123103**

**Soporte cuadrado cónico**

Acabado cromo

PVP: 3,80 €



# FLEXOS



**123104**  
**Flexo extensible cónico**  
 De 1,50 - 2,00 m  
 Doble grapado  
 PVP: 6,20 €



**123107**  
**Flexo extensible cónico**  
 1,75 - 2,25 m  
 Doble grapado  
 PVP: 6,90 €



**123108**  
**Flexo cónico**  
 1,50 m  
 Para grifo extraíble  
 PVP: 8,90 €



**123114**  
**Flexo PVC gris**  
 1,50 m  
 PVP: 11,00 €



**123105**  
**Flexo cónico reforzado**  
 1,70 m  
 Doble grapado  
 PVP: 5,70 €



**123117**  
**Flexo para bidet / inodoro**  
 1,20 m  
 Flexo cónico reforzado antitorsión  
 PVP: 7,50 €



**123116**  
**Flexo cónico**  
 1,50 m  
 Para grifo extraíble  
 Rosca 3/8  
 PVP: 8,90 €



**123119**  
**Flexo metálico blanco**  
 1,50 m  
 PVP: 11,00 €



**123109**  
**Flexo acero inoxidable**  
 0,60 m  
 Doble tuerca hexagonal  
 PVP: 4,80 €



**123115**  
**Flexo PVC negro mate**  
 1,50 m  
 PVP: 11,00 €



**123106**  
**Flexo para bidet / inodoro**  
 1,20 m  
 Flexo PVC negro mate  
 PVP: 11,00 €



**123112**  
**Flexo cónico bronce**  
 1,70 m  
 PVP: 16,00 €



**123118**  
**Flexo cónico oro**  
 1,70 m  
 PVP: 17,00 €



**123120**  
**Flexo cónico oro**  
 1,20 m  
 PVP: 14,00 €

# VÁLVULAS CLIC-CLAC

**123401**

**Válvula clic-clac N.1**

Con rebosadero

PVP: 13,60 €

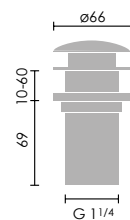

**123403**

**Válvula clic-clac N.3**

Con rebosadero. Alto 60

PVP: 13,90 €

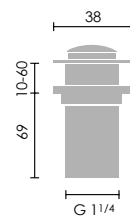

**123404**

**Válvula clic-clac universal**

Cromo

PVP: 13,90 €

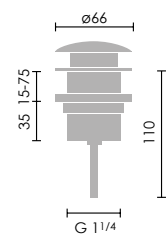

**123413**

**Válvula clic-clac universal tapón pequeño**

Con rebosadero

PVP: 13,00 €

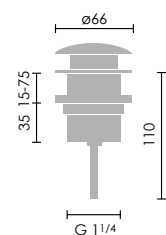

**123402**

**Válvula clic-clac N.2 bronce**

Con rebosadero

PVP: 18,50 €

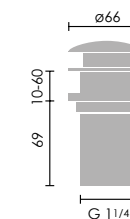

**123421**

**Válvula clic-clac tapón de porcelana**

Blanco

PVP: 18,500 €

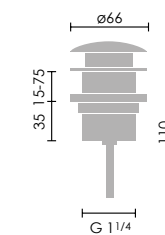

**123404GM**

**Válvula clic-clac universal**

Gris Metal

PVP: 22,00 €

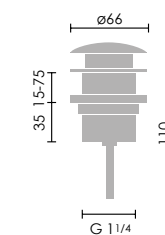

**123404NG**

Negro mate

PVP: 17,00 €

**123404BL**

Blanco

PVP: 17,00 €

**123404Rc**

Rosa cepillado

PVP: 21,00 €

**123404OR**

Oro cepillado

PVP: 21,00 €

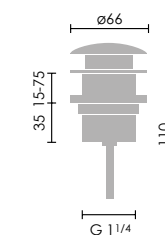

# REPUESTOS

■ BARRAS DE DUCHA	347
■ SOPORTE DESLIZANTE	347
■ PLAFONES Y EXCÉNTRICAS	348
■ CARTUCHOS Y MONTURAS	348
■ DISTRIBUIDORES	349
■ DUCHAS BIDÉ / INODORO	349
■ MANETAS	350
■ VOLANTES	350
■ MANETA MEDICA	350
■ AIREADORES	351

## BARRAS DE DUCHA

### Barra de ducha de 130 cm

<b>121901</b>	Cromo	PVP: 70,00 €
<b>121901NG</b>	Negro	PVP: 94,00 €
<b>121901BL</b>	Blanco	PVP: 84,00 €
<b>121901OR</b>	Oro	PVP: 94,00 €
<b>121901RC</b>	Rosa	PVP: 94,00 €
<b>121901OGM</b>	Gris	PVP: 94,00 €

### Barra de ducha de 155 cm

<b>121902</b>	Cromo	PVP: 90,00 €
<b>121902NG</b>	Negro	PVP: 120,00 €
<b>121902OR</b>	Oro	PVP: 120,00 €



## SOPORTE DESLIZANTE

### Redondo

<b>123100</b>	Cromo	PVP: 7,00 €
<b>123100NG</b>	Negro	PVP: 8,00 €
<b>123100BL</b>	Blanco	PVP: 8,00 €
<b>123100OR</b>	Oro	PVP: 9,00 €

### Cuadrado

<b>123111</b>	Cromo	PVP: 7,00 €
<b>123111NG</b>	Negro	PVP: 8,00 €



## PLAFONES Y EXCÉNTRICAS

### Juego completo

<b>20301</b>	Cuadrado	PVP: 11,00 €
<b>20302</b>	Redondo	PVP: 9,00 €
<b>123306</b>	Estándar	PVP: 6,00 €
<b>123307</b>	Gigante	PVP: 14,00 €



## CARTUCHOS Y MONTURAS

<b>20201</b>	25 mm	PVP: 9,00 €
<b>20202</b>	35 mm S.D.	PVP: 10,00 €
<b>20203</b>	35 mm S.L.	PVP: 10,00 €
<b>20204</b>	40 mm S.D.	PVP: 10,00 €
<b>20205</b>	40 mm S.L.	PVP: 10,00 €
<b>20206</b>	35 mm S.L.	PVP: 10,00 € Apertura en frío lavabo.
<b>20207</b>	35 mm S.L.	PVP: 10,00 € Apertura en frío fregadero



<b>20105</b>	Cerámica 1/4 vuelta	PVP: 9,00 €
<b>20106</b>	Osmosis	PVP: 10,00 €
<b>20107</b>	Medical M-5C Cerámica	PVP: 10,00 €
<b>20108</b>	Temporizado	PVP: 10,00 €
<b>20109</b>	Andros	PVP: 45,00 €
<b>20110</b>	Índico	PVP: 45,00 €
<b>20111</b>	Ártico	PVP: 45,00 €



## DISTRIBUIDORES

**20207** M3/4 - M1/2 - H3/4 PVP: 14,00 €  
Olympic / Titanic



**20209** M3/4 - M1/2 - H3/4 PVP: 16,00 €



## DUCHAS BIDÉ/INODORO

### Pistola ABS

**121125** Cromo PVP: 6,00 €



### Pistola Redonda LATÓN

**121126** Cromo PVP: 20,00 €

**121126NG** Negro PVP: 24,00 €

**121126OR** Oro PVP: 24,00 €

**121126RC** Rosa PVP: 24,00 €

**121126GM** Gris PVP: 24,00 €



### Pistola Cuadrada

**121118** Cromo PVP: 19,00 €

**121118NG** Negro PVP: 21,00 €

## MANETAS

<b>20015</b>	CÍES	PVP: 10,00 €
<b>20001</b>	KU	PVP: 11,00 €
<b>20001NG</b>	KU NEGRO	PVP: 12,00 €
<b>20005</b>	VARTA	PVP: 10,00 €
<b>20013</b>	YDRA	PVP: 10,00 €
<b>20012</b>	KÍOS	PVP: 10,00 €
<b>20002</b>	BONN	PVP: 8,00 €
<b>20003</b>	KOBA	PVP: 8,00 €
<b>20003NG</b>	KOBA NEGRO	PVP: 9,00 €
<b>20004</b>	JADE	PVP: 8,00 €
<b>20014</b>	ZURICH	PVP: 8,00 €
<b>20006</b>	ALFA	PVP: 7,00 €



## VOLANTES

<b>20009</b>	Classic cromo	PVP: 5,80 €
<b>20010</b>	Classic bronce	PVP: 6,70 €



## MANETA MEDICAL

<b>20007</b>	1 Agua	PVP: 16,00 €
<b>20008</b>	2 Aguas. Larga	PVP: 10,00 €
<b>20011</b>	2 Aguas. Corta	PVP: 10,00 €



## AIREADORES

### Cromo

<b>123309</b>	Flexo corto aireador 22 H-24M	PVP: 4,60 €
<b>123301</b>	Aireador hembra 22 mm	PVP: 1,40 €
<b>123301-20</b>	Aireador hembra 20 mm	PVP: 1,50 €
<b>123301-18</b>	Aireador hembra 18 mm	PVP: 1,50 €
<b>123302</b>	Aireador macho 24 mm	PVP: 1,40 €
<b>123302-20</b>	Aireador macho 20 mm	PVP: 1,50 €
<b>123302-18</b>	Aireador macho 18 mm	PVP: 1,50 €
<b>123303</b>	Aireador macho 28 mm	PVP: 2,40 €



### Bronce

<b>123301-BR</b>	Aireador hembra 22 mm	PVP: 1,90 €
<b>123302-BR</b>	Aireador macho 22 mm	PVP: 1,90 €



### Oro

<b>123301-OR</b>	Aireador hembra 22 mm	PVP: 3,50 €
<b>123302-OR</b>	Aireador macho 24 mm	PVP: 3,50 €
<b>123303-OR</b>	Aireador macho 28 mm	PVP: 6,70 €



# CERTIFICADOS

Laboratoire habilité par le Ministère chargé de la santé en application de l'article R\*.1321-52 du code de la santé publique

**euofins** | Expertises Environnementales

## ATTESTATION DE CONFORMITE SANITAIRE

### Certificate of sanitary conformity

Conformément à l'arrêté du 29 mai 1997 modifié et à la circulaire du Ministère de la Santé  
Direction Générale de la Santé DGS/SD7A N° 571 du 25 Novembre 2002

**Coordonnées du demandeur d'ACS / Contact details of the ACS owner :**

**KAIPING KCITEC SANITARY COMPONENTS Co., & Ltd**  
No. 21-22 Baishitou Area A, Yueshan Town  
Kaiping City, Guangdong Province  
CHINA, 529300

**Nom de l'accessoire représentatif / Reference of the representative accessory :**

**Cartouche thermostatique TC34 S B ZZZ**

N° de dossier attribué par le laboratoire habilité / File reference : **17 ACC NY 143**

Date de réalisation des essais d'inertie selon la norme XP P41-280 / Tests date (according to the standard XP P 41-280) : /

Commentaires / Comments : Aucun essai n'est nécessaire à l'émission de cette ACS / No testing is required to issue this ACS.

**Famille d'accessoires couverte par l'ACS / Accessories' family covered by this certificate :**

**CARTOUCHES THERMOSTATIQUES KCITEC**

**Références / References :** (2 articles et leurs variantes)  
TC27 T Y ZZZ  
TC34 S Y ZZZ

Y peut se remplacer par B ou W.  
ZZZ est le numéro de série de 000 à 999

**Attestation délivrée par / Certificate issue by :**

Clémence Tafforeau  
Chef de Service / Materials Department Manager

Signature : 

Date de délivrance / Date of issue : 18 avril 2017  
Date d'expiration / Expiry date : 18 avril 2022

Commentaires / Comments : /

Eurofins Expertises Environnementales  
SAS au capital de 71676 € RCS Nancy 751 058 102 TVA FR 35 751 056 102  
Siège social : Rue Lucien Cuénot site Saint Jacques II BP 51005 54521 MAXEVILLE cedex - T 03 83 50 36 17 F 03 83 50 23 70

Référence : T-AM-FO26360      1/1      Version : 15.2      Date publication : 19.11.2015



*This certifies that*

**NINGBO WANHAI CARTRIDGE TECHNOLOGY CO. LTD.**

*has had the undermentioned product(s) examined, tested and certified as being of an appropriate quality and standard as required in the Water Supply (Water Fittings) Regulations and Scottish Water Byelaws, subject to scheme requirements being met when installed.*

*Model Numbers*

\*30D-11: 29.83mm OD.  
35D-1: 34.90mm OD.  
40D-1: 39.84mm OD.  
35H-1: 34.74mm OD.  
40H-1: 40.02mm OD.  
35PH-10B: 34.96mm OD.  
LT35D-11: 34.88mm OD.  
LT35D-13: 35mm OD.  
W25H: 24.9 mm OD.  
35D-1-K: 34.82mm OD.  
40D-1-K: 39.69mm OD.  
35H-1-K: 34.81mm OD.  
40H-1-K: 39.82mm OD.  
W25D-K: 24.90mm OD.  
W25H-K: 24.76mm OD. cartridge headworks \*

*The certificate by itself is not evidence of a valid WRAS Approval. Confirmation of the current status of an approval must be obtained from the WRAS Approvals Directory (www.wras.co.uk/directory)*

*The product so mentioned will be valid until the end of:*

**November 2026**

*Certificate No.*

**2111324**



Ian Hughes,  
WRAS Approvals Manager

**CARSO - LABORATOIRE SANTÉ ENVIRONNEMENT HYGIÈNE DE LYON**

Laboratoire Agréé pour les analyses d'eaux par le Ministère de la Santé

Laboratoire habilité par le Ministère chargé de la santé en application de l'article R\*.1321-52 du code de la santé publique

## ATTESTATION DE CONFORMITE SANITAIRE

### Certificate of sanitary conformity

Conformément à l'arrêté du 29 mai 1997 modifié et à la circulaire du Ministère de la Santé  
Direction Générale de la Santé DGS/SD7A 2002 n°571 du 25 novembre 2002

**Coordonnées du demandeur des essais / Contact details of the ACS owner :**

**NINGBO WANHAI CARTRIDGE TECHNOLOGY CO., LTD.**  
Xiachen Development Zone,  
Chunhu, Fenghua,  
Ningbo, Zhejiang  
P.R. CHINA

**Nom de l'accessoire représentatif / Reference of the representative accessory :**

**Cartouche céramique / Ceramic cartridge 26H-11**

N° de dossier attribué par le laboratoire habilité / File reference : **22 ACC LY 421**

Date de réalisation des essais d'inertie selon la norme XP P41-280 / Aucun essai n'est nécessaire pour délivrer l'ACS  
Tests date (according to the standard XP P 41-280) : No testing is required to issue this ACS

Commentaires : Les composants organiques sont conformes à l'arrêté du 29 mai 1997 modifié. Les composants métalliques sont conformes à l'arrêté du 25 juin 2020.  
Comments : Organic components are compliant with the decree dated 29th May 1997 modified. Metallic components are compliant with the decree dated 25th June 2020.

**Famille d'accessoires couverte par l'ACS / Accessories' family covered by this certificate :**

**Cartouches céramique / Ceramic cartridges**

**Références / References (53 references) :**

25DK-1	26H-11	35H-2	40D-1FX	40PH
25DK-2	35D-1	35H-10	40D-2	360° 35D-1
25D-QH	35D-1B	35HPK	40D-3	360° 35D-2
35D-1T	35D-1F	35P-1	40D-10	360° 35H-1
35D-2	35D-1FD	35PH-1	40DPK	360° 35H-2
35D-3	35D-1FX	35PH-10	40H-1	360° 40D-1
40D-1T	35D-7	35PH-10B	40H-2	360° 40D-2
25D-1	35D-10	D36-1S	40H-10	360° 40H-1
25D-2	35D-10SP	40D-1	40HSX	360° 40H-2
25DPK	35DPK	40D-1B	40P-1	
26H-10	35H-1W	40D-1F	40PH-1	

**Attestation délivrée par :** Christelle AUTUGELLE  
Responsable Laboratoire MCDE  
CARSO - L.S.E.H.L.

Signature : 

A la date du / Date of issue : 15 Juillet 2022  
Date d'expiration / Expiration date : 15 Juillet 2027

Commentaires / Comments : renouvellement / renewal 17 ACC LY 448

E. MC060-P-15/09/2014 M11N  
Score de Reconnaissance de Signaux de 2 283 622,38 Euros - RCS Lyon B 410 545 313 - SIRET 410 545 313 00042 - APE 743 B - N° TVA : FR 82 410 545 313  
Siège Social et laboratoire : 4, avenue Jean Moulin - CS 30228 - F - 69633 VIENISSEUX cedex - Tél. : (33) 04 72 76 16 16 - Fax : (33) 04 78 72 35 03  
Site web : www.groupecarso.com - e-mail : mcde@groupecarso.com

## Condiciones generales de venta

1. Los precios incluidos en el presente catálogo tarifa son precios de venta al público.
2. A los precios indicados se les incrementará el IVA correspondiente.
3. CLAUS Y BATH, S.L. se reserva el dominio de las mercancías suministradas hasta el cobro integro de las mismas.
4. CLAUS Y BATH, S.L. no admitirá ninguna devolución por roturas en transporte transcurridas 24 horas de la recepción de la misma y siendo indispensable haber indicado en el talón de entrega de la agencia, la frase PENDIENTE DE REVISAR, EMBALAJE DAÑADO, o cualquier otra similar que nos permita efectuar la reclamación al seguro del transporte, teniendo un plazo de 1 DÍA HÁBIL para poder efectuar dicha reclamación.
5. Las devoluciones de mercancía siempre se realizarán por el medio de transporte que CLAUS Y BATH, S.L. designe y este será el encargado de dar la orden de recogida.
6. Sólo se consideran válidos los PAGOS efectuados directamente a CLAUS Y BATH, S.L., o a la persona que la represente, en cuyo caso siempre serán nominativos a CLAUS Y BATH, S.L.
7. Todos los productos de CLAUS Y BATH, S.L. tienen una GARANTÍA de dos años contra cualquier defecto de fabricación.
8. No se incluyen en la garantía los desperfectos causados por golpes, uso de productos químicos o abrasivos, por manipulación o instalación incorrecta, o los causados por impurezas del agua, etc.
9. No se repondrá ninguna grifería completa cuando la pieza defectuosa pueda ser sustituida.
10. Los clientes al realizar cualquier pedido, que deberán ser por correo electrónico o fax, aceptan todas las condiciones generales de venta reflejadas en este catálogo tarifa.
11. CLAUS Y BATH, S.L. se reserva el derecho de modificar, sin previo aviso, precios y condiciones generales de venta, así como características técnicas, componentes o medidas de los productos reflejados en este dossier, ya sean por razones técnicas o comerciales.
12. Los portes en Península serán pagados a partir de 150 euros. Para pedidos inferiores se cargarán 5 euros en factura.
13. En caso de producirse litigio, serán competentes los Tribunales de Valencia, con renuncia expresa a cualquier otro fuero.
14. Esta tarifa de precios anula todas las anteriores.



**[www.clausybath.com](http://www.clausybath.com)**

- C/ Pascual Esteve Miquel, 3
- 46940 MANISES Valencia
- Tel. 96 001 58 99
- WhatsApp: 0034 665 88 88 84
  
- [pedidos@clausybath.com](mailto:pedidos@clausybath.com)